



CATALOGUE
OF
ELEMENTS



KNOT TYPE 1

Data sheet:

-  Material: metal
-  Function: roof structure
-  flexible joint

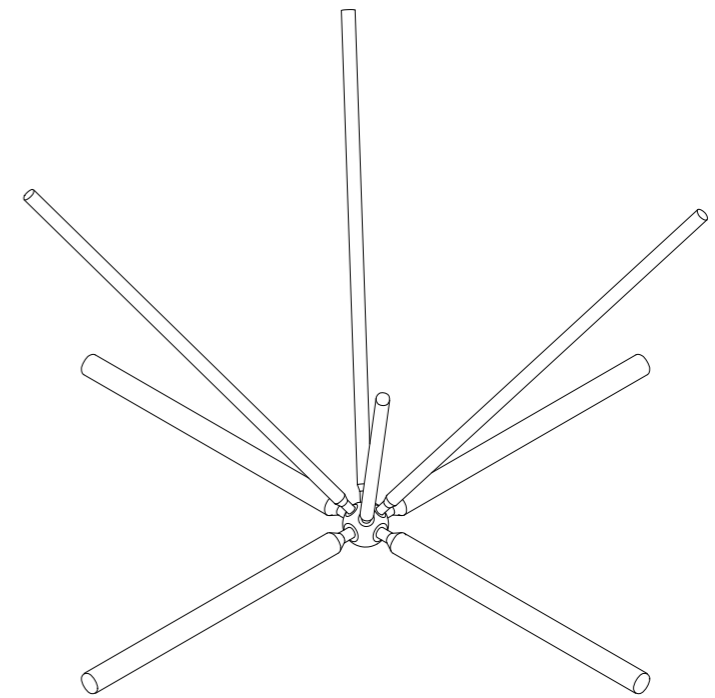

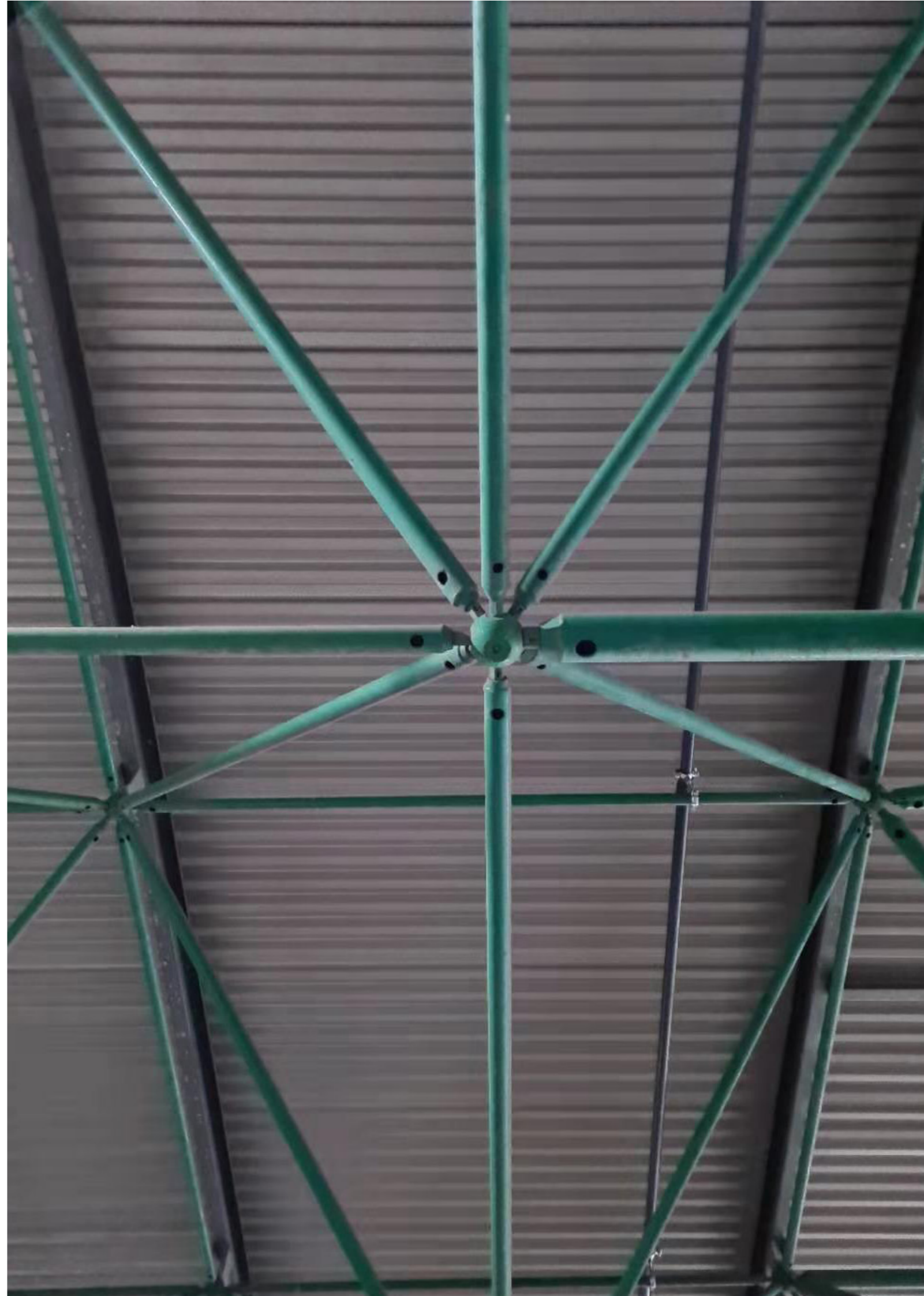
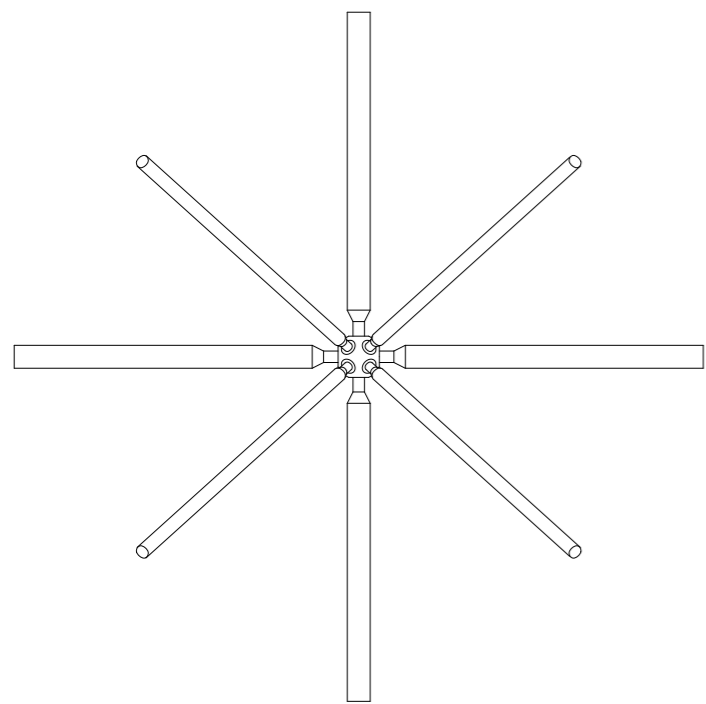
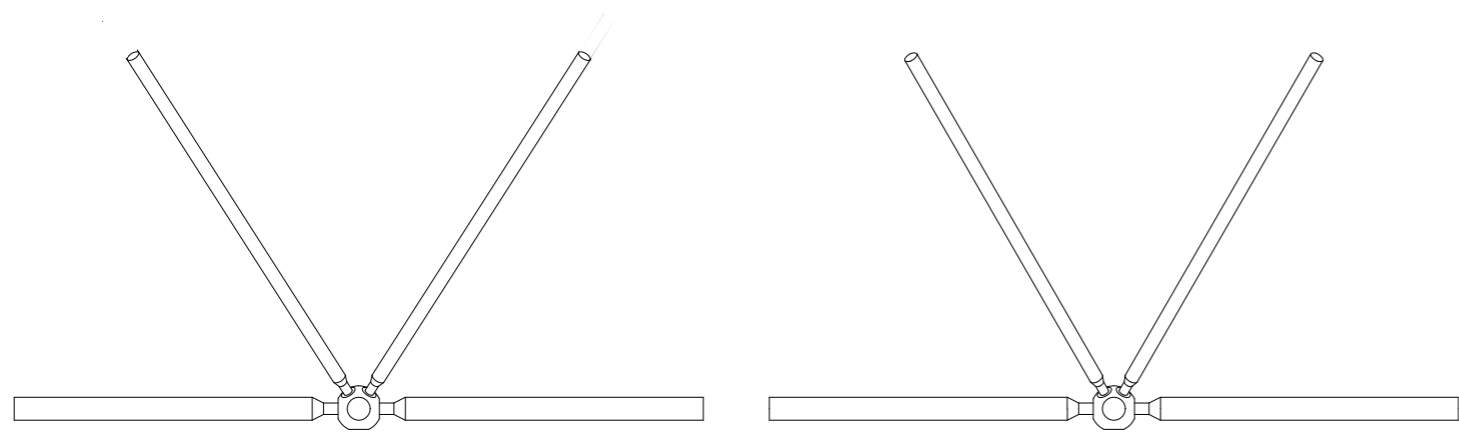



MOVEABLE OBJECT

Data sheet:

- Material: metal
- function: transportation, mobile shelf
adjustable shelf system
- screwed and welded joints

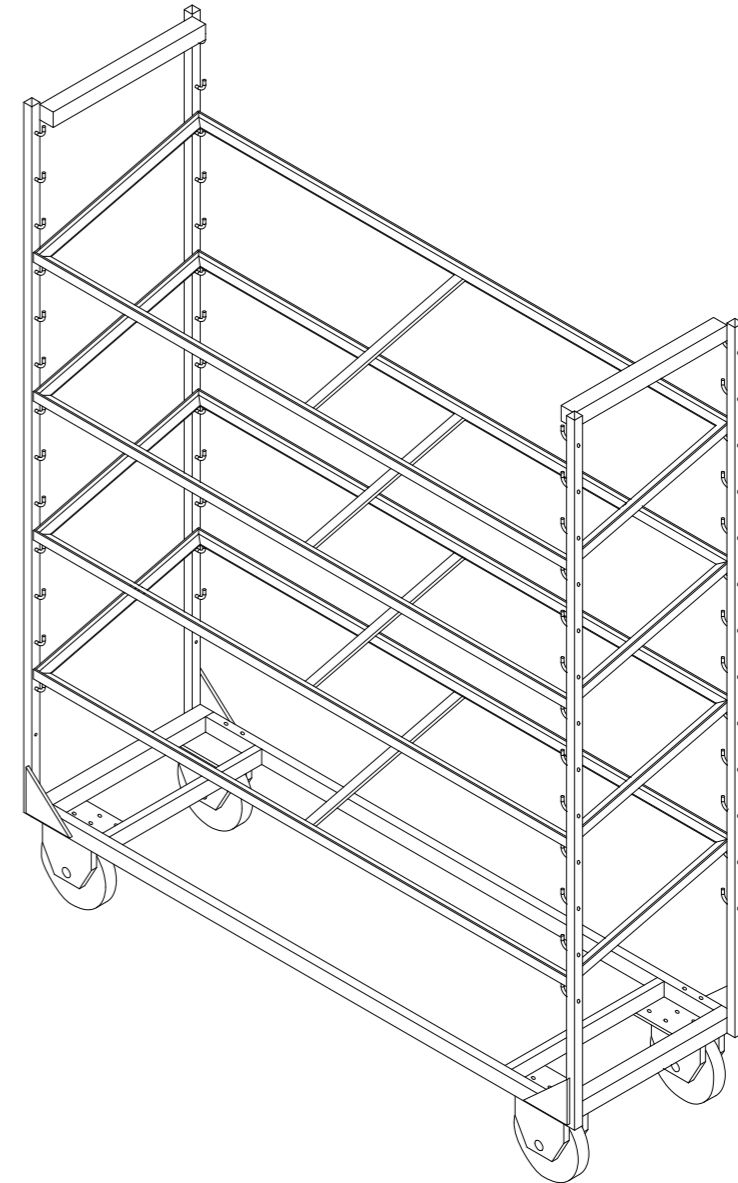

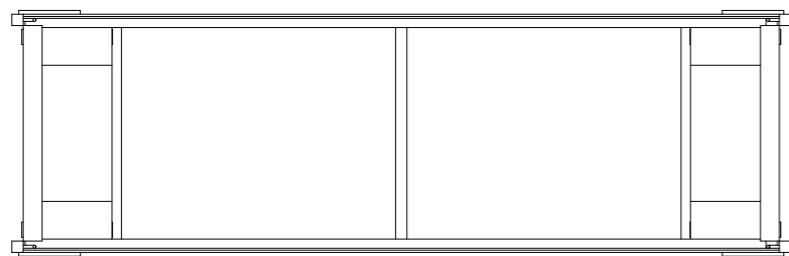
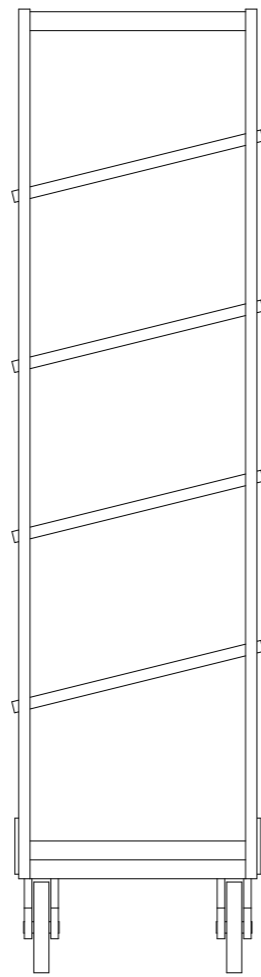
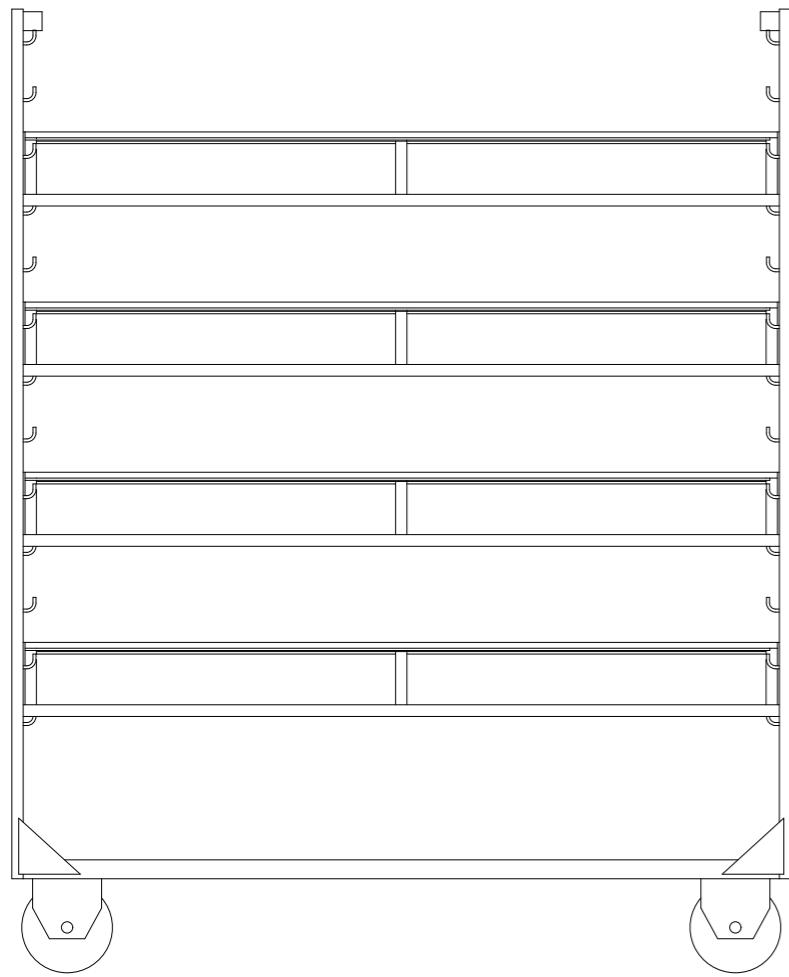



FIXED OBJECT

Date sheet:

- Material: metal
- function: ladder
- fixed position, welded joints

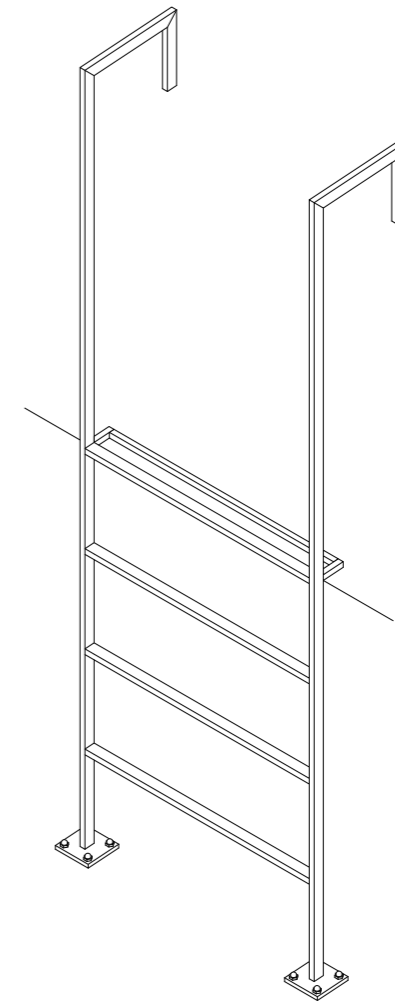

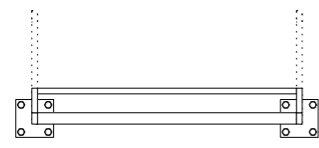
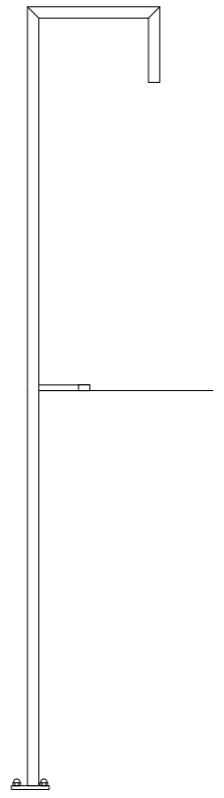
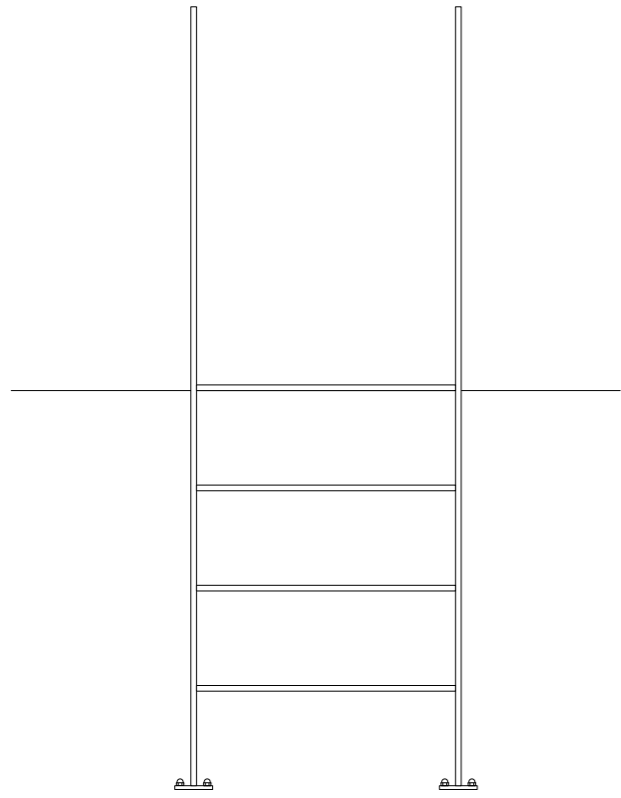



EQUIPMENT 1

Data sheet:

- Material: metal
- function: transportation
- welded joints, rotating axis

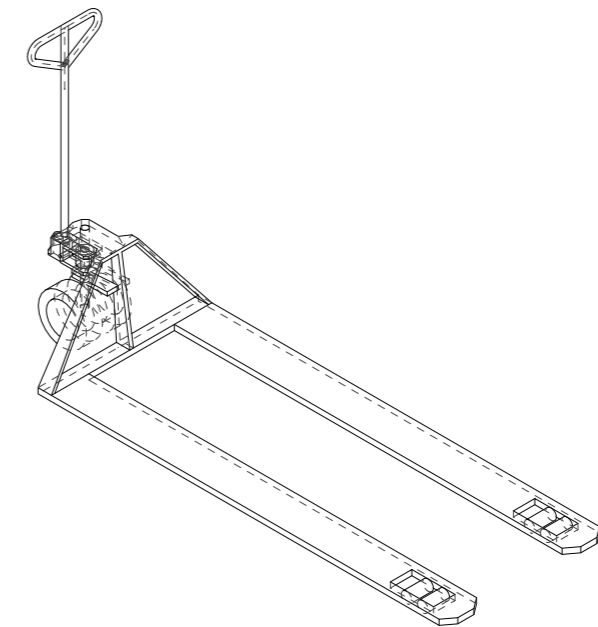

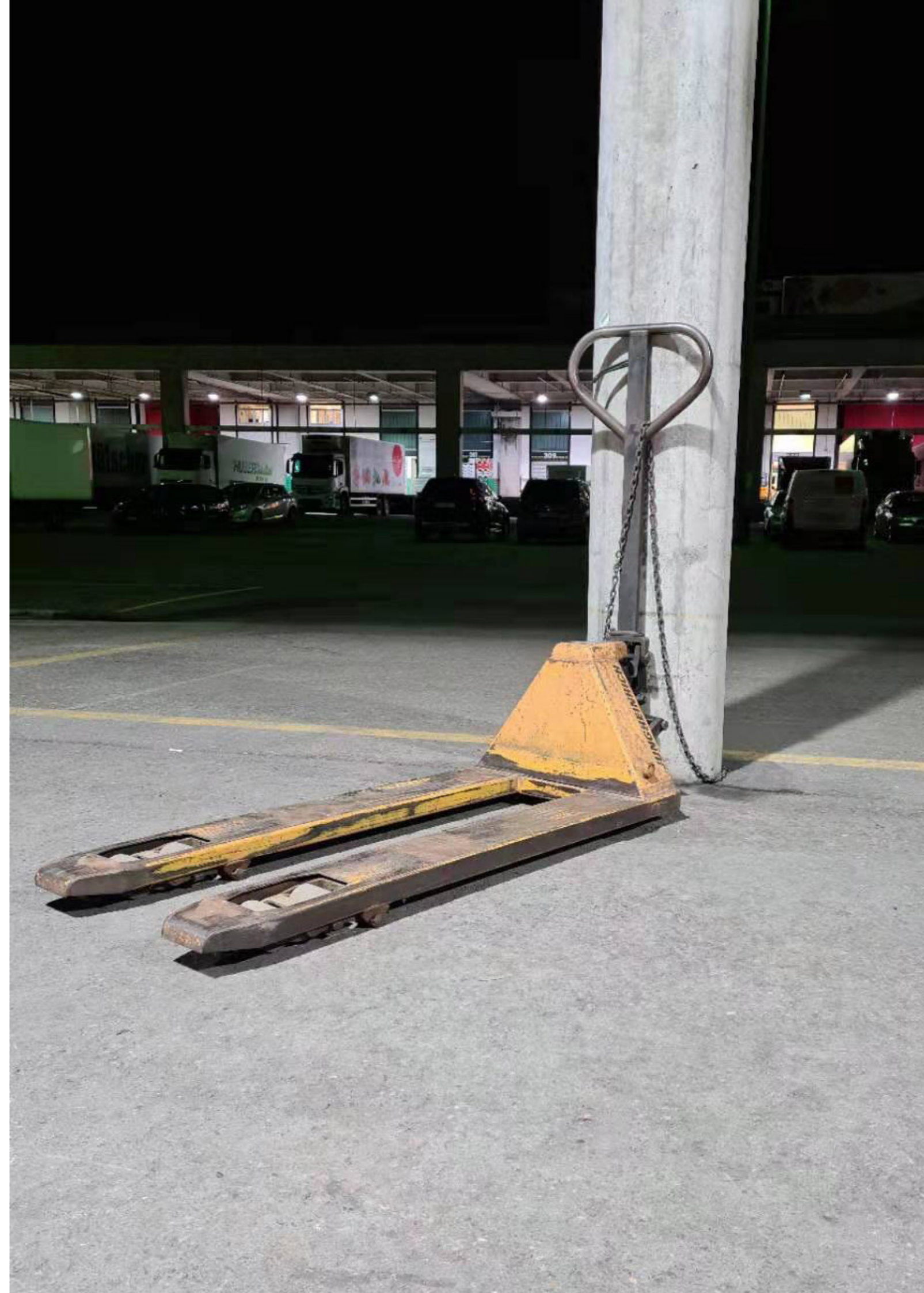
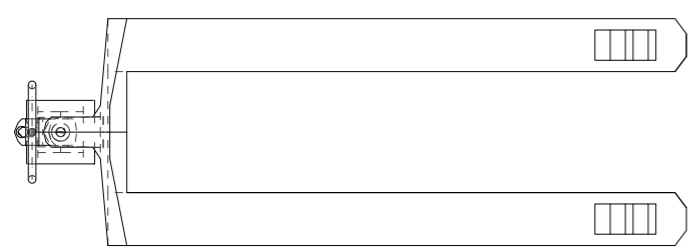
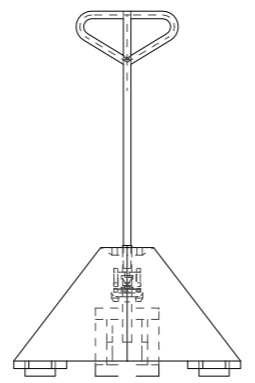



EQUIPMENT 2

Data sheet:

- Material: metal
- function: transportation
- screwed and welded joints

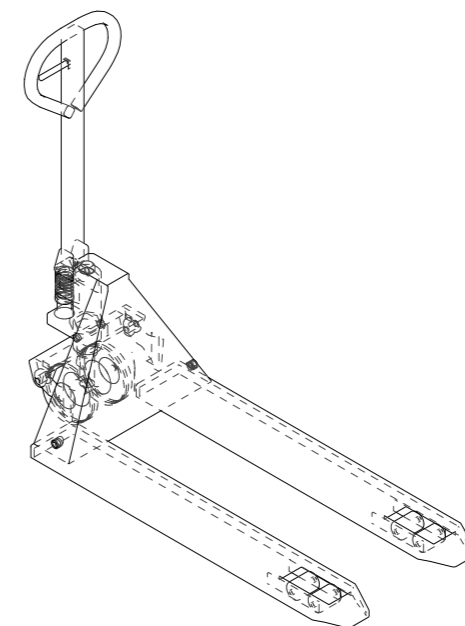

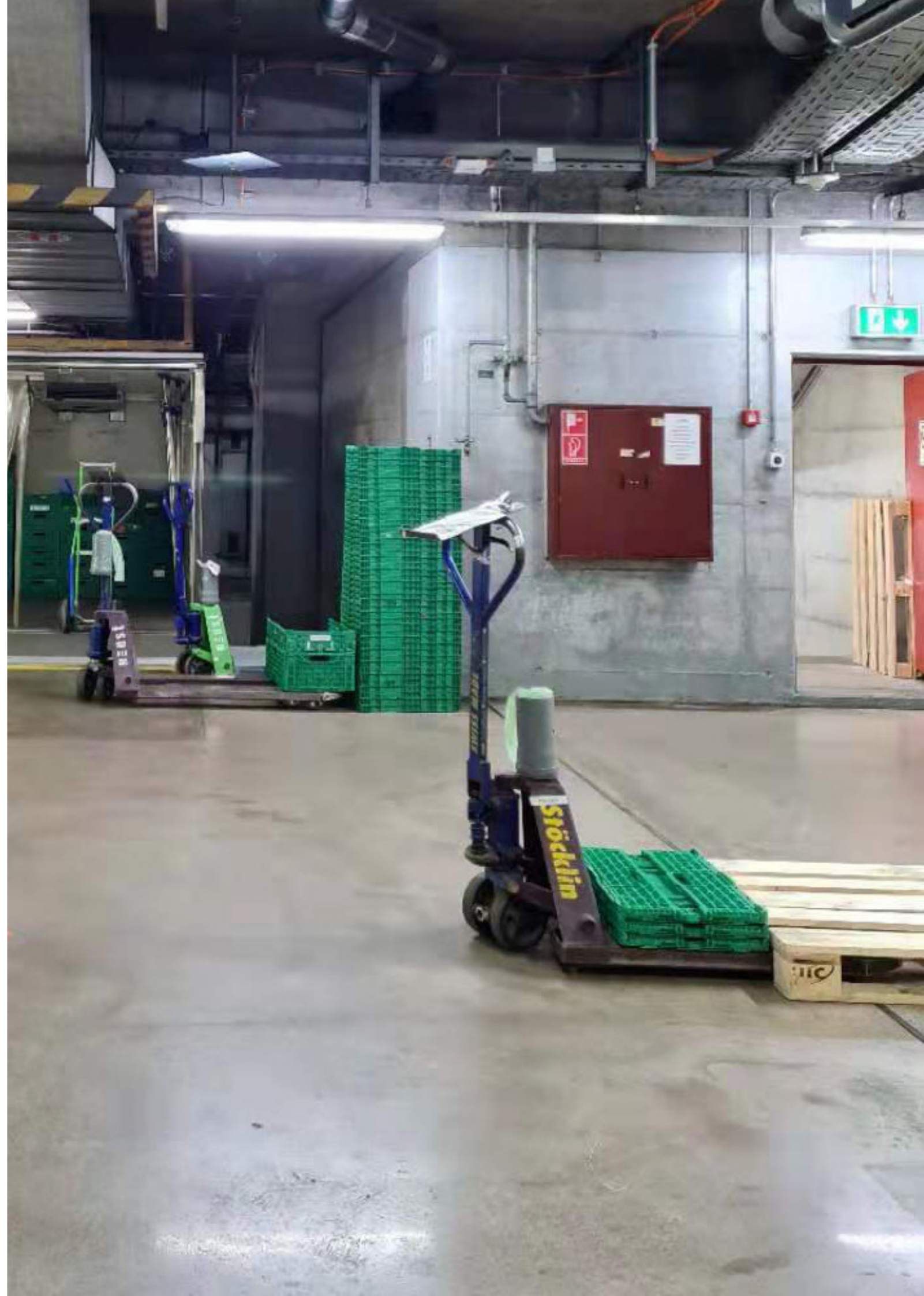
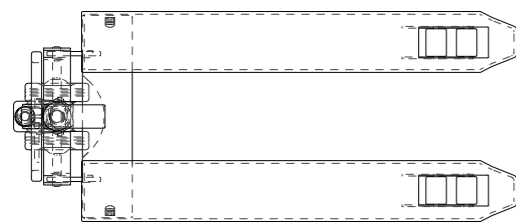
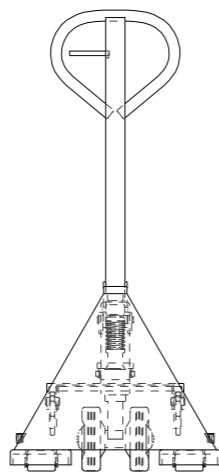
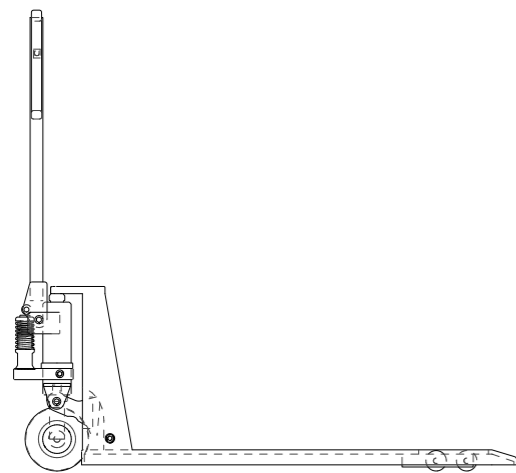





MOVEABLE ELEMENT

Data sheet:

-  Material: metal
-  Function: barrier
-  welded joints

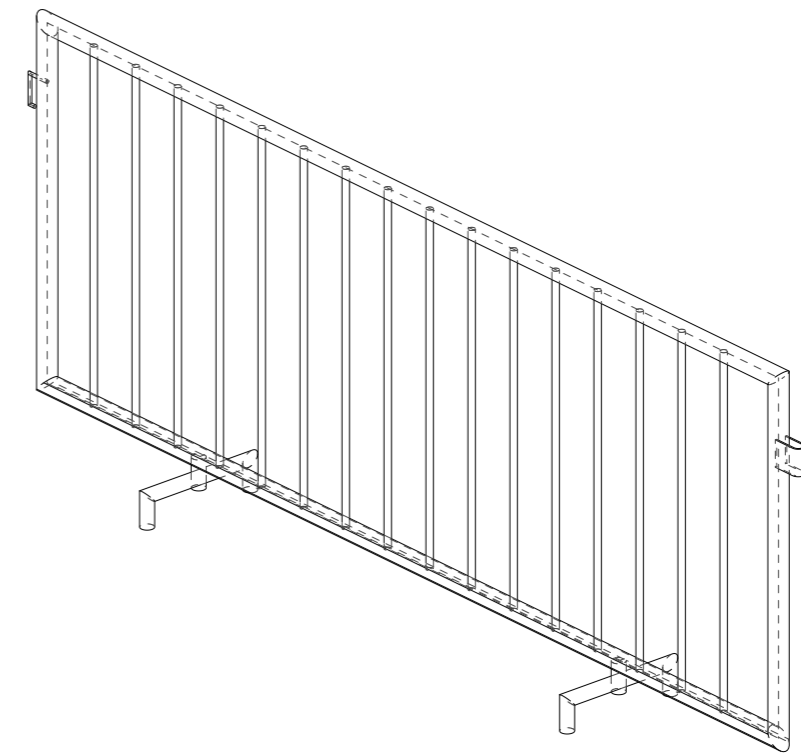

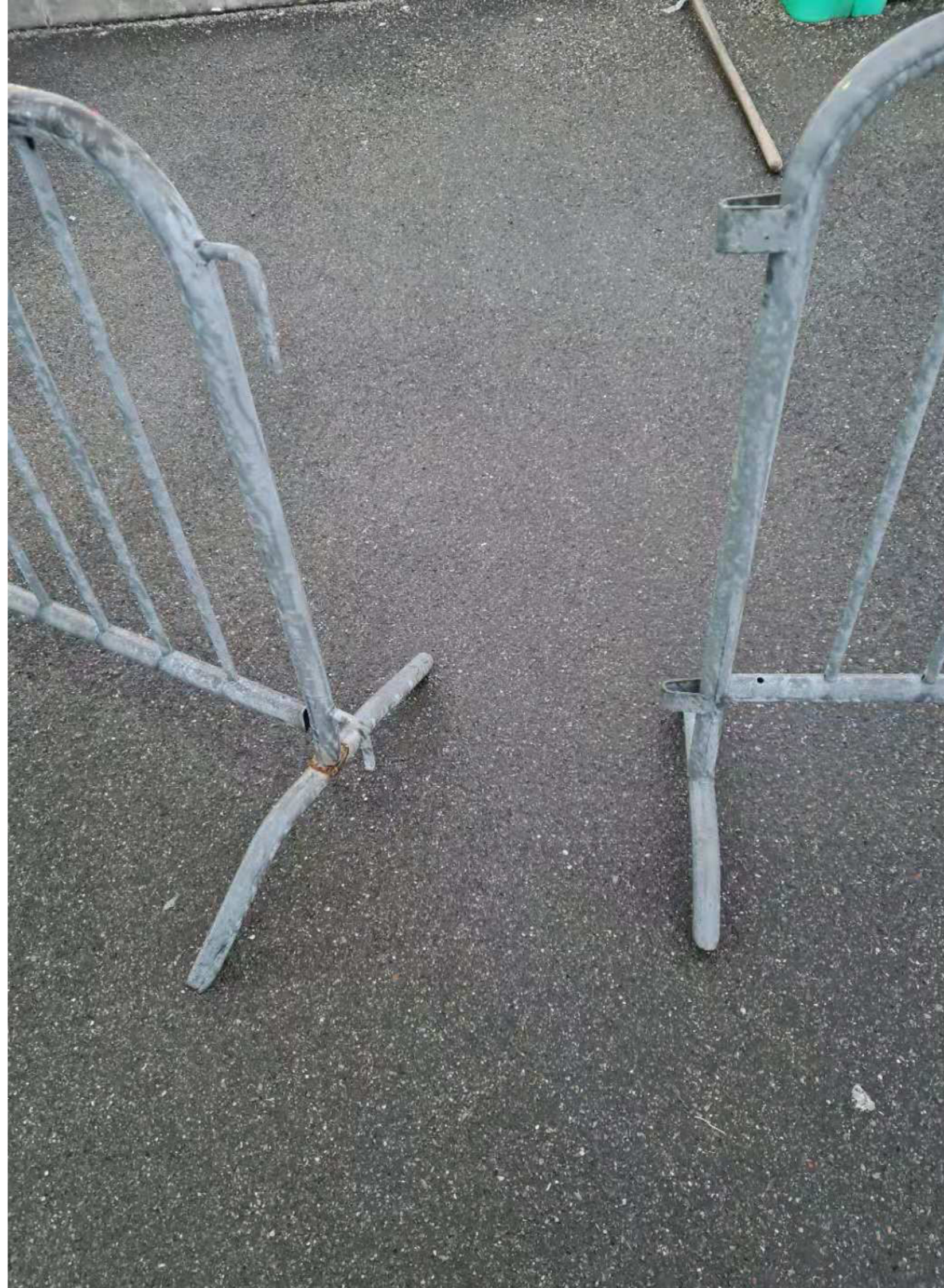
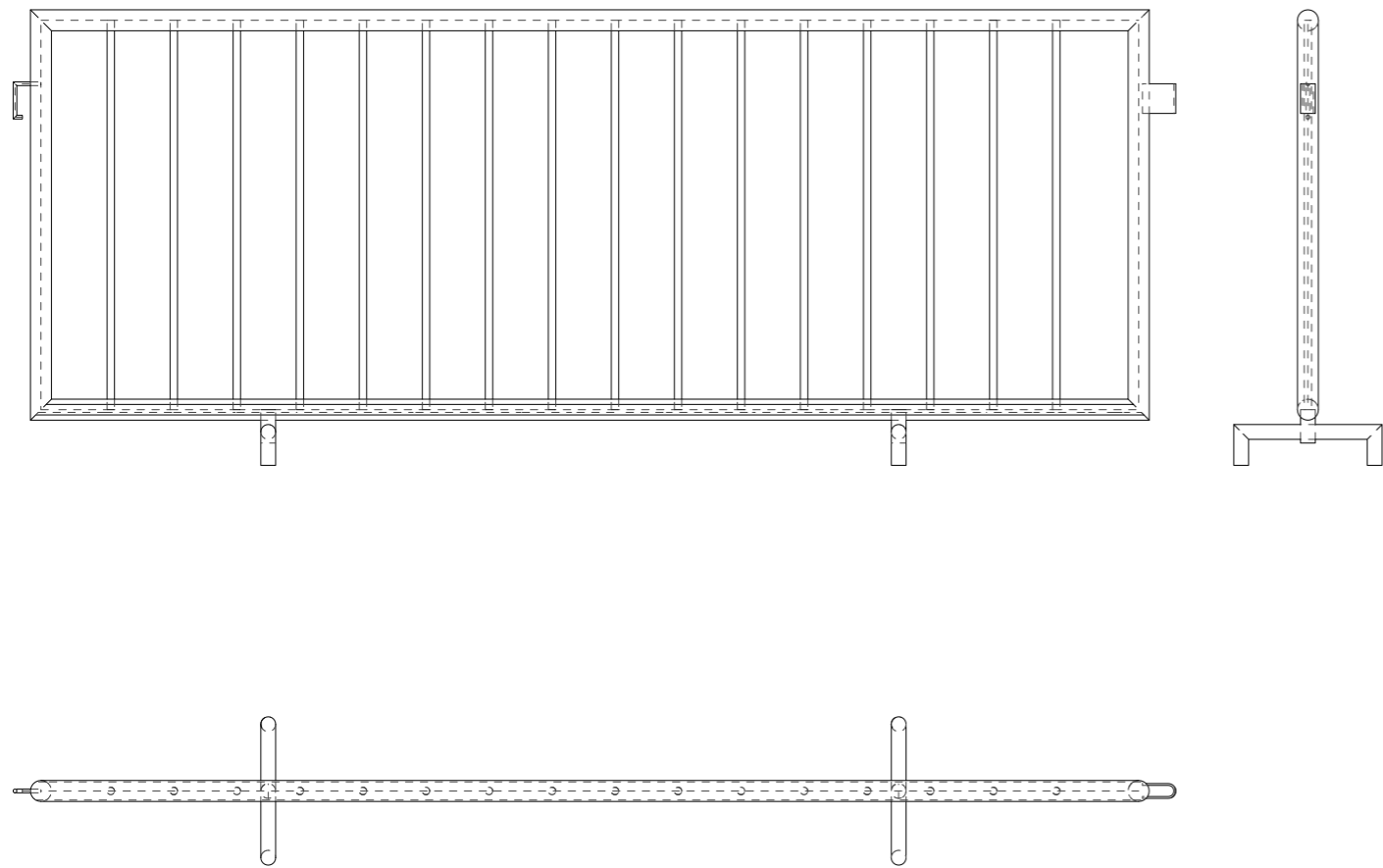





STORAGE ELEMENT

Data sheet:

-  Material: wood
-  Function: storage, transport
-  nail joints

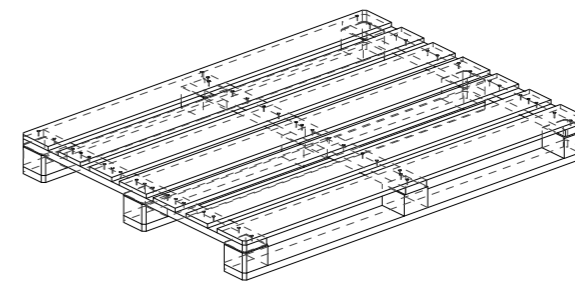

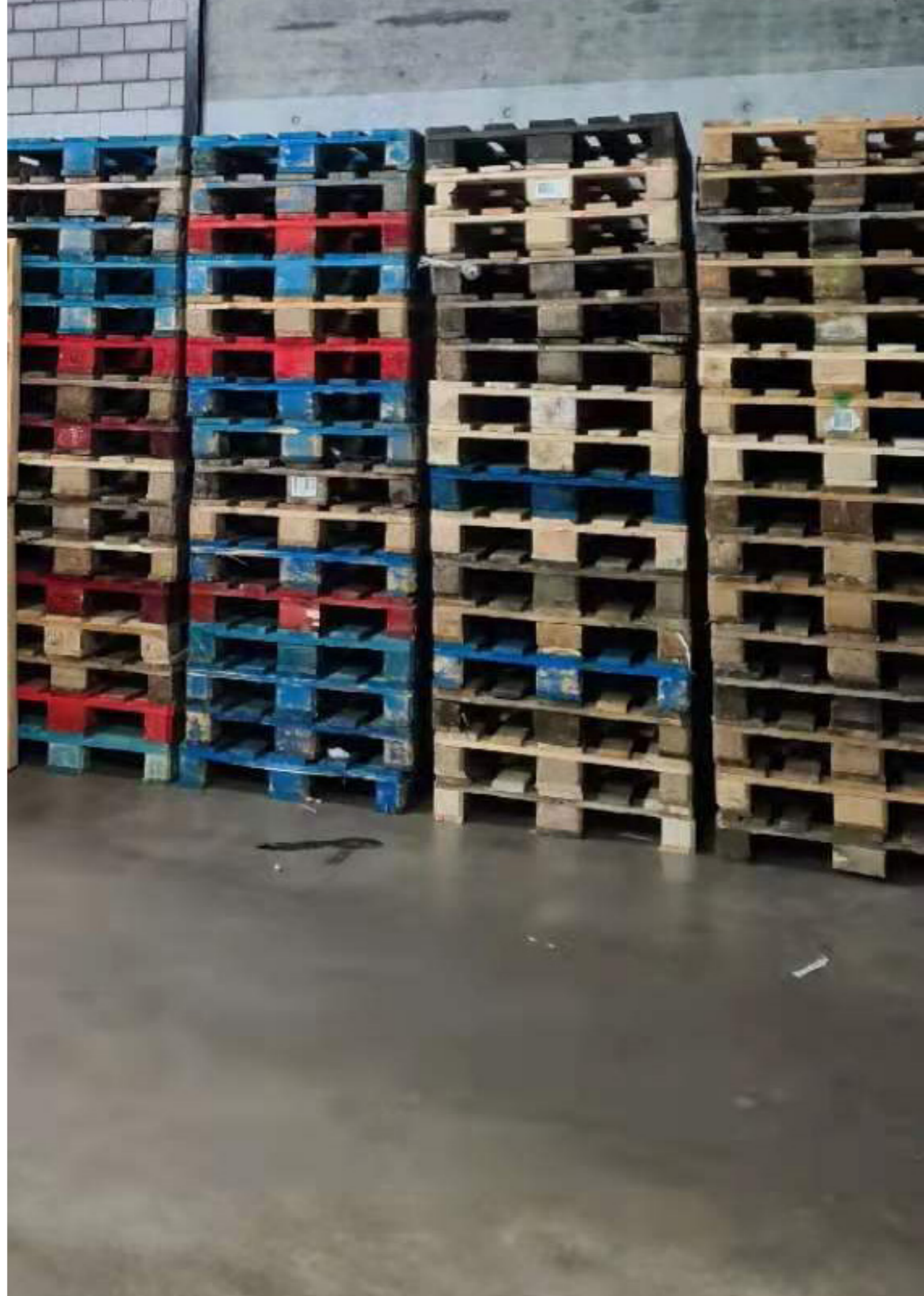
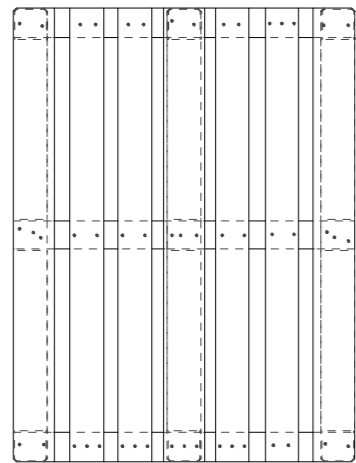
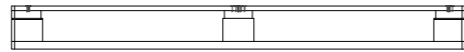
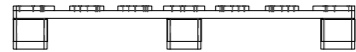



EQUIPMENT 3

Date sheet:

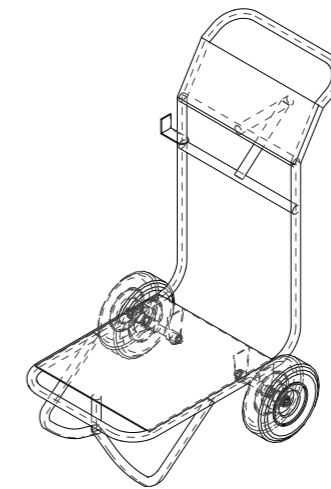

- Material: metal
- function: transportation
- welded joints





S STORAGE OBJECT

Data sheet:

-  Material: metal
-  function: storage
-  welded joints

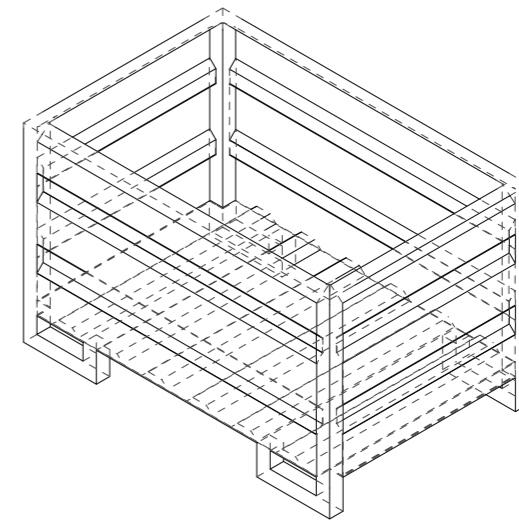

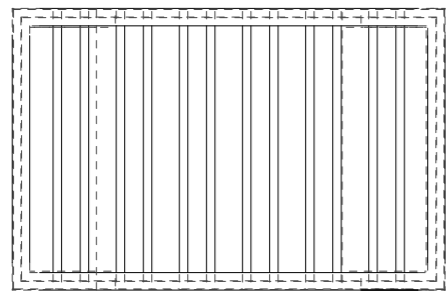
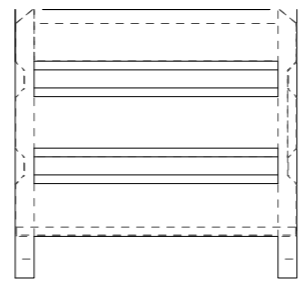
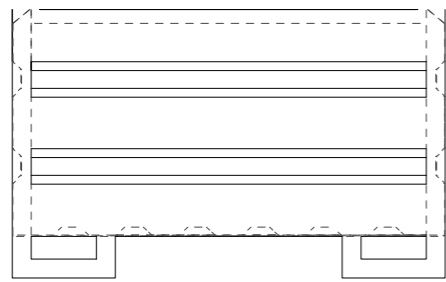



STORAGE OBJECT

Data sheet:

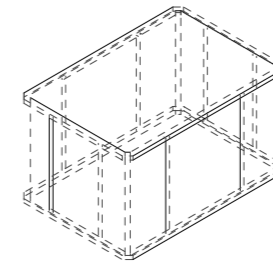

- Material: plastic
- function: storage, transport
- shaped solid





NEW ELEMENT 1

Data sheet:

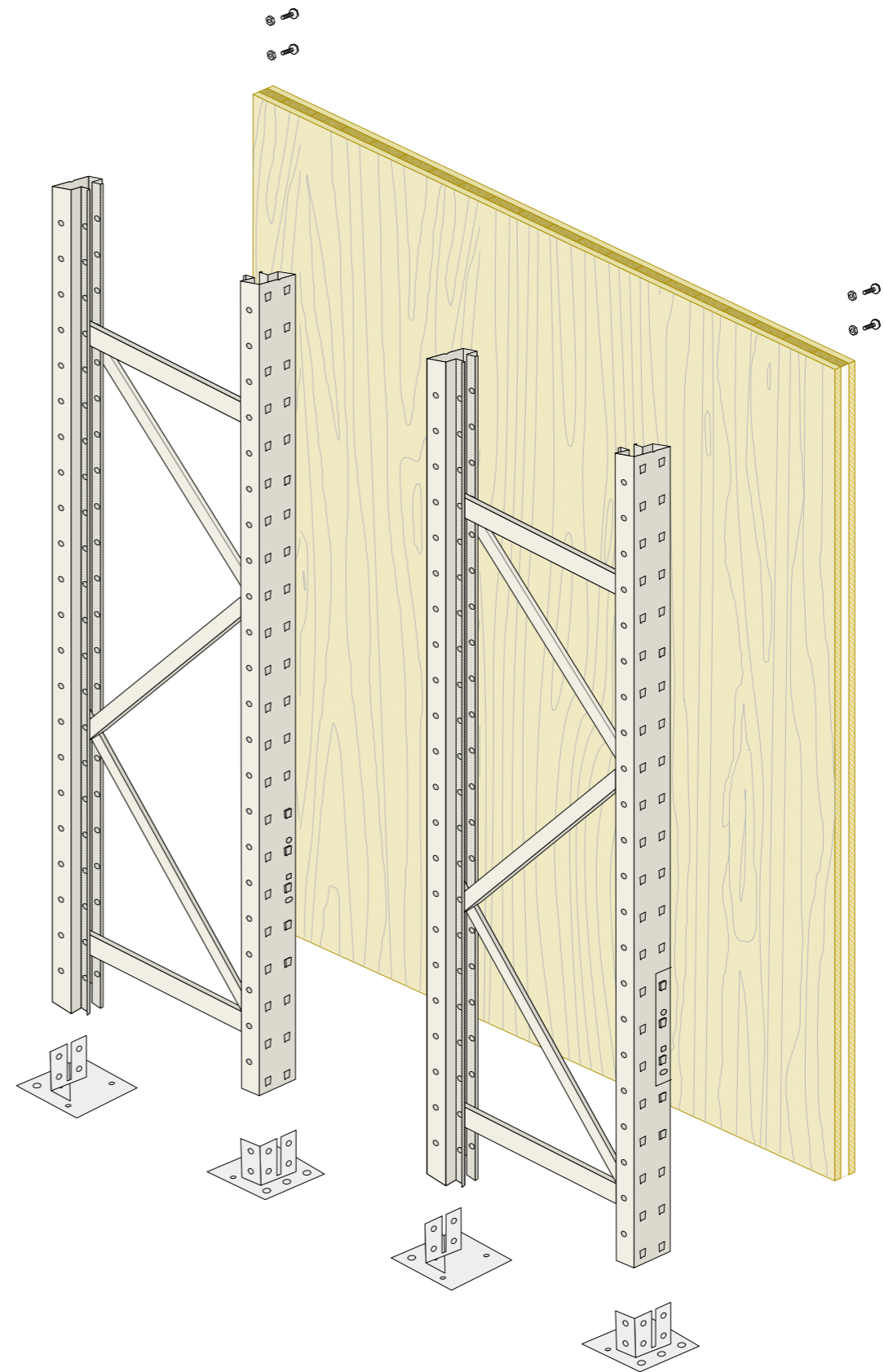

-  Material: colored plywood, metal
-  function: dividing wall
-  screw joints





NEW ELEMENT 2

Data sheet:

-  Material: metal
-  function: shelf and dividing wall
-  screw joints

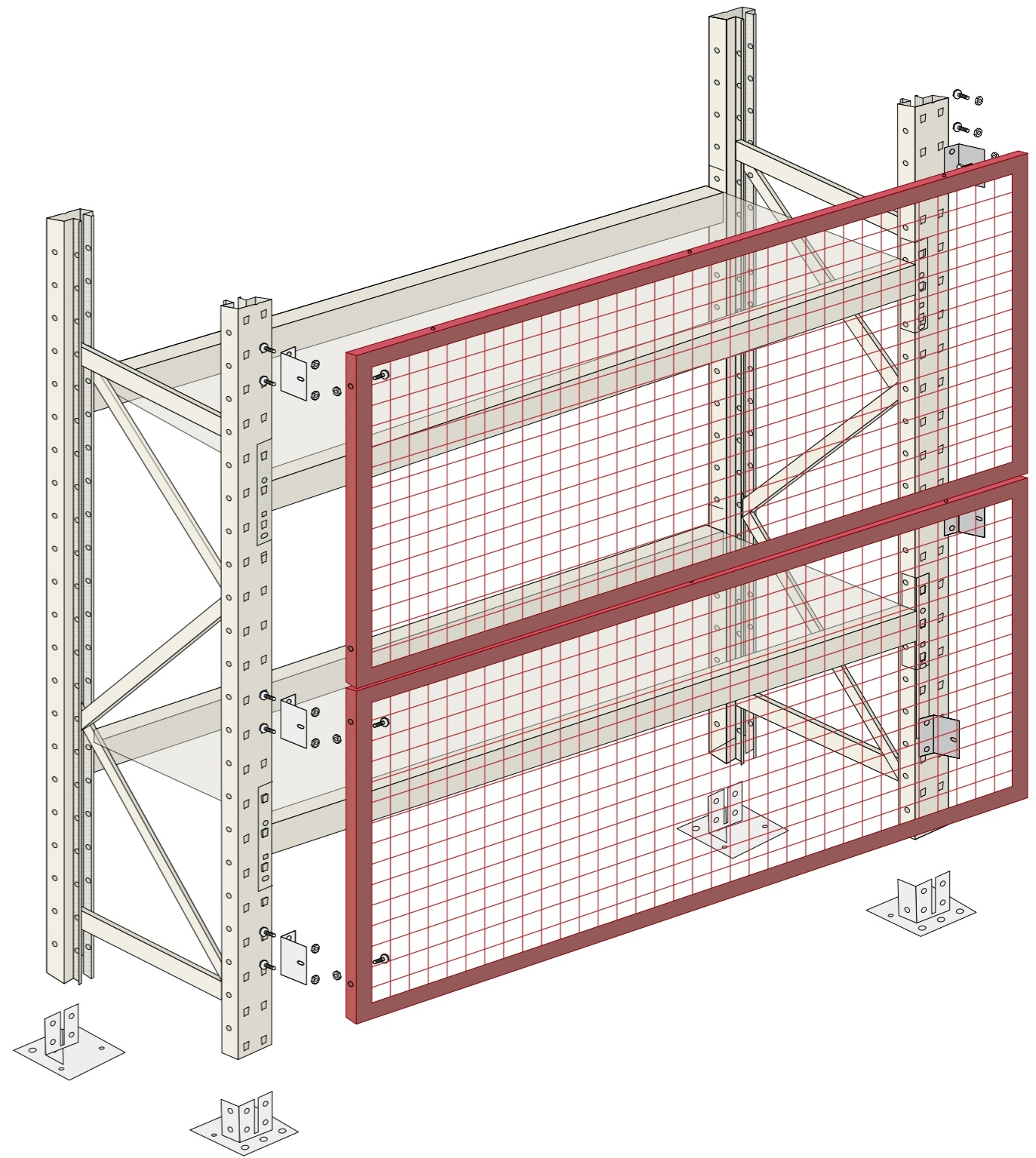



NEW ELEMENT 3

Data sheet:

- Material: metal, painted perforated wood
- function: climbing wall
- screw joints

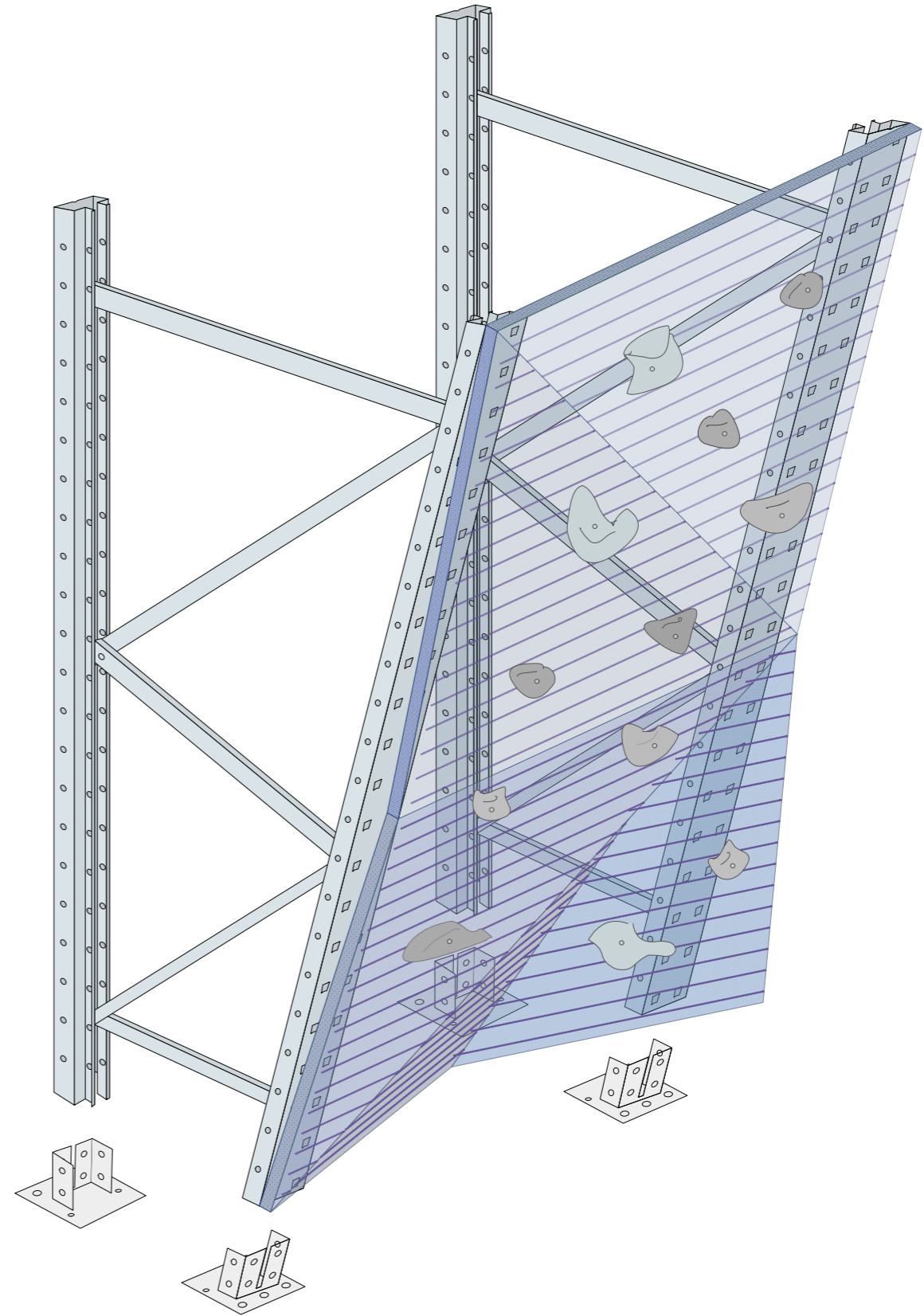



NEW ELEMENT 4

Data sheet:

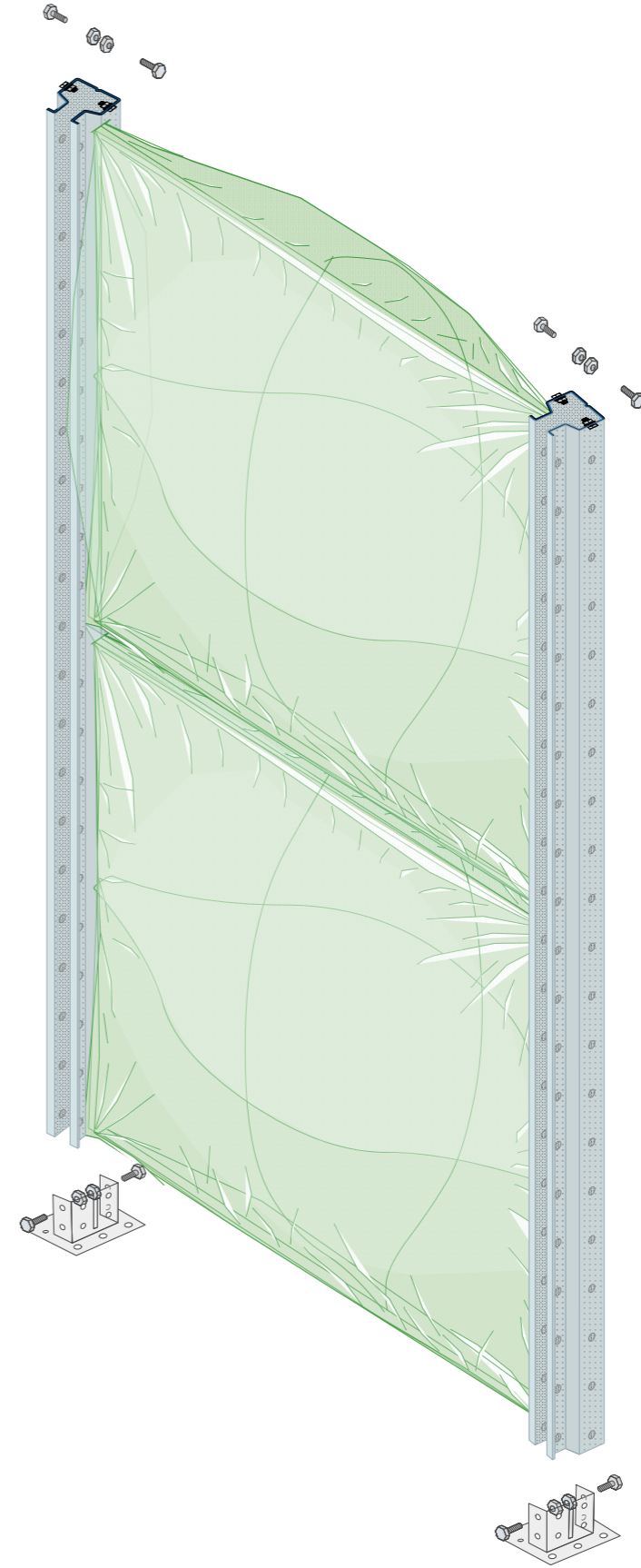

- Material: Metal, recycled plastic
- function: soft acrobatics wall
- welded joints, screwed framework





NEW ELEMENT 5

Data sheet:

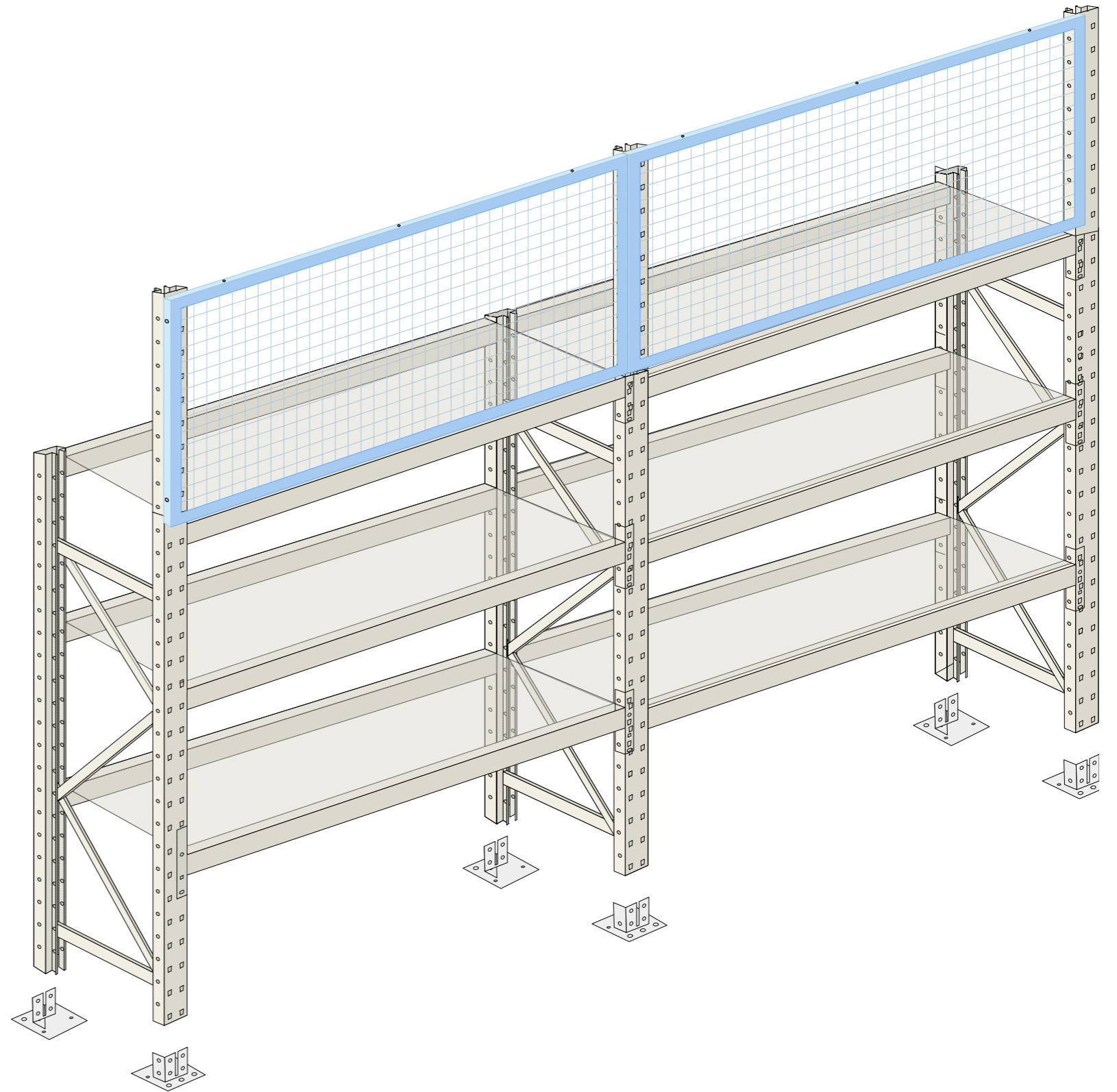

-  Material: metal
-  Function: bridge, dividing wall, shelf
-  screw joints





NEW ELEMENT 6

Data sheet:

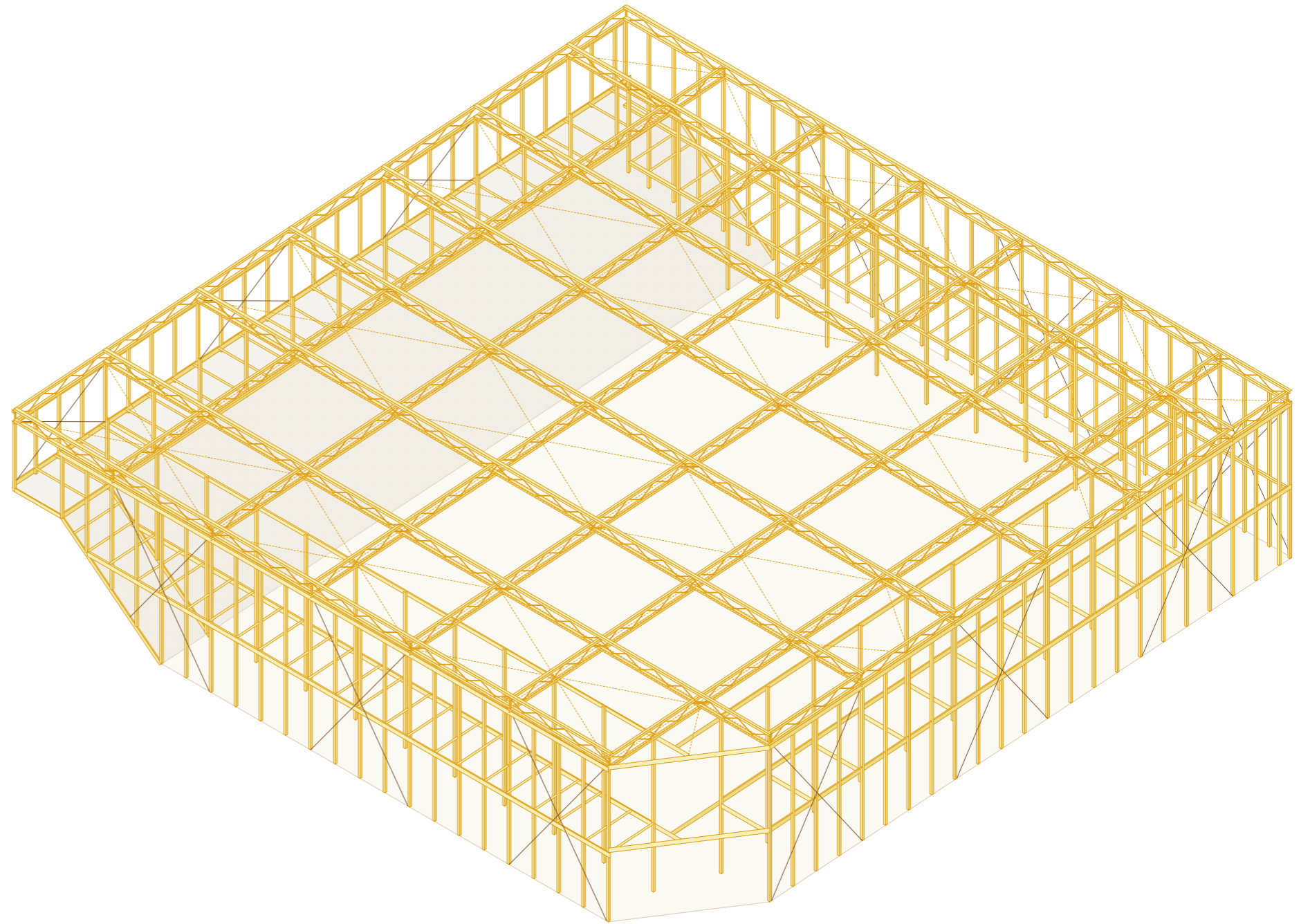

-  Material: painted metal
-  Function: e-Sports spatial structure
-  screw joints





NEW ELEMENT 7

Data sheet:

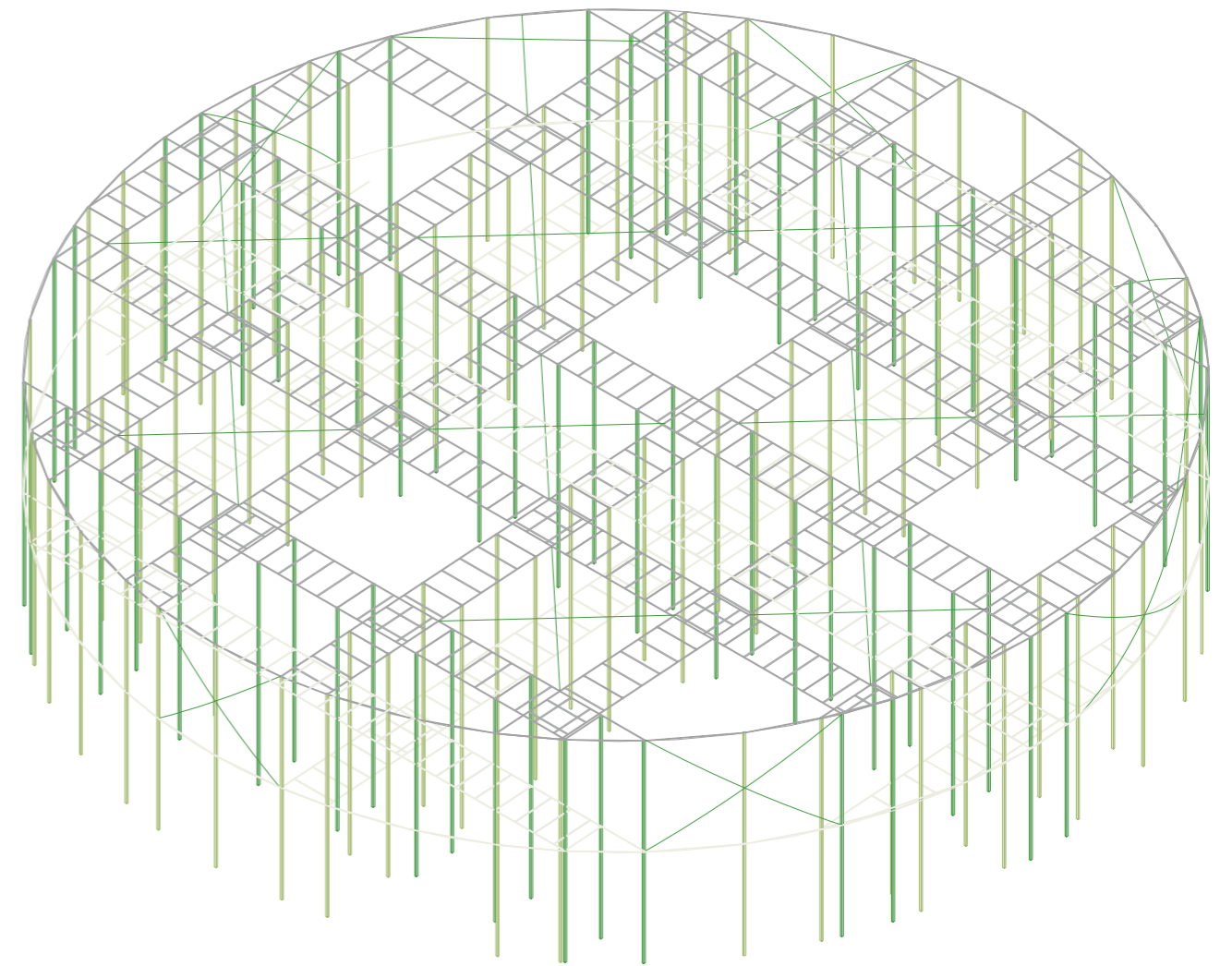

-  Material: metal
-  function: structure, pavillon
-  screw joints





NEW ELEMENT 8

Data sheet:

-  Material: wood, metal, textile
-  Function: seating, furniture
-  screw joints

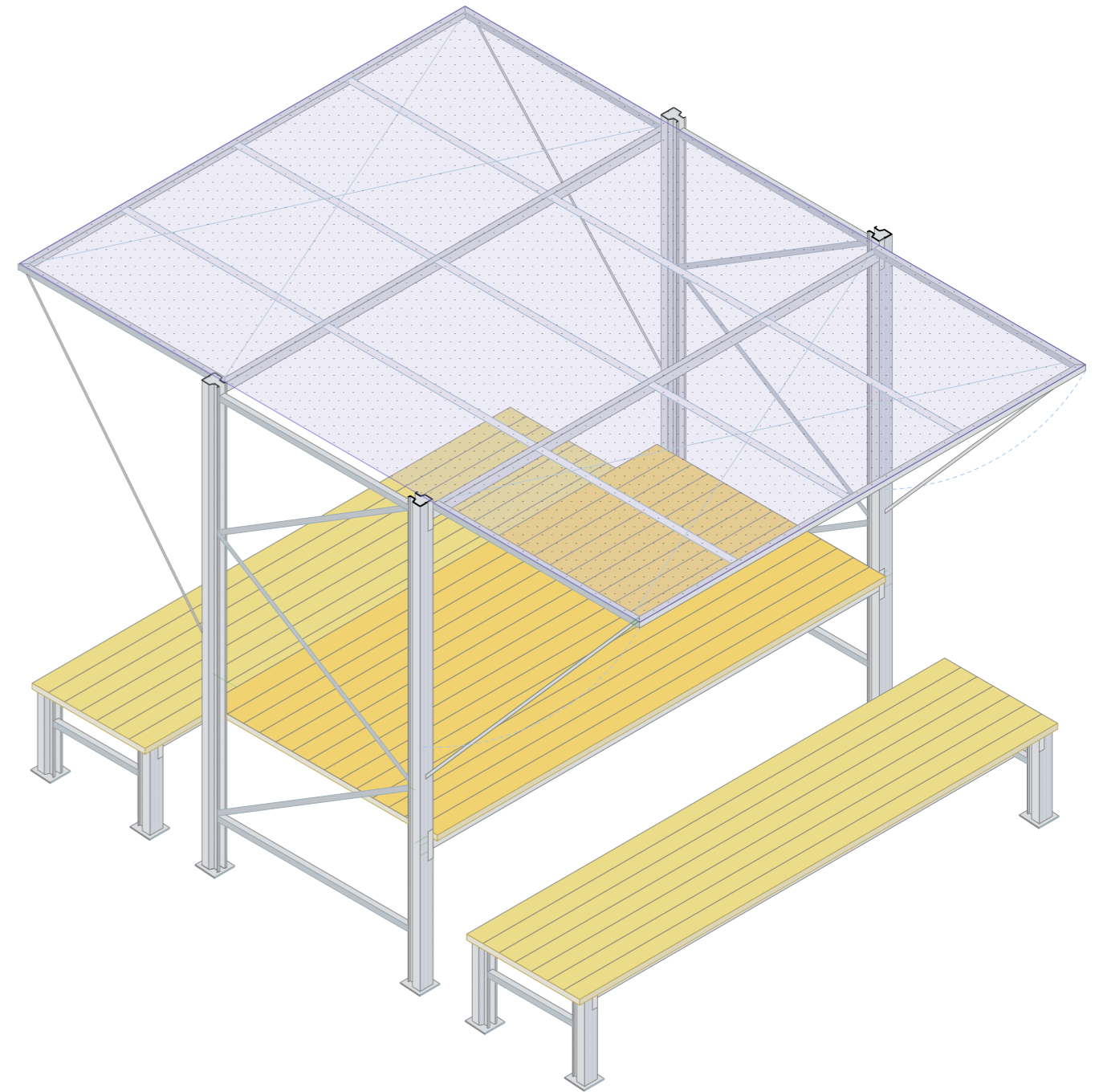



NEW ELEMENT 9

Data sheet:

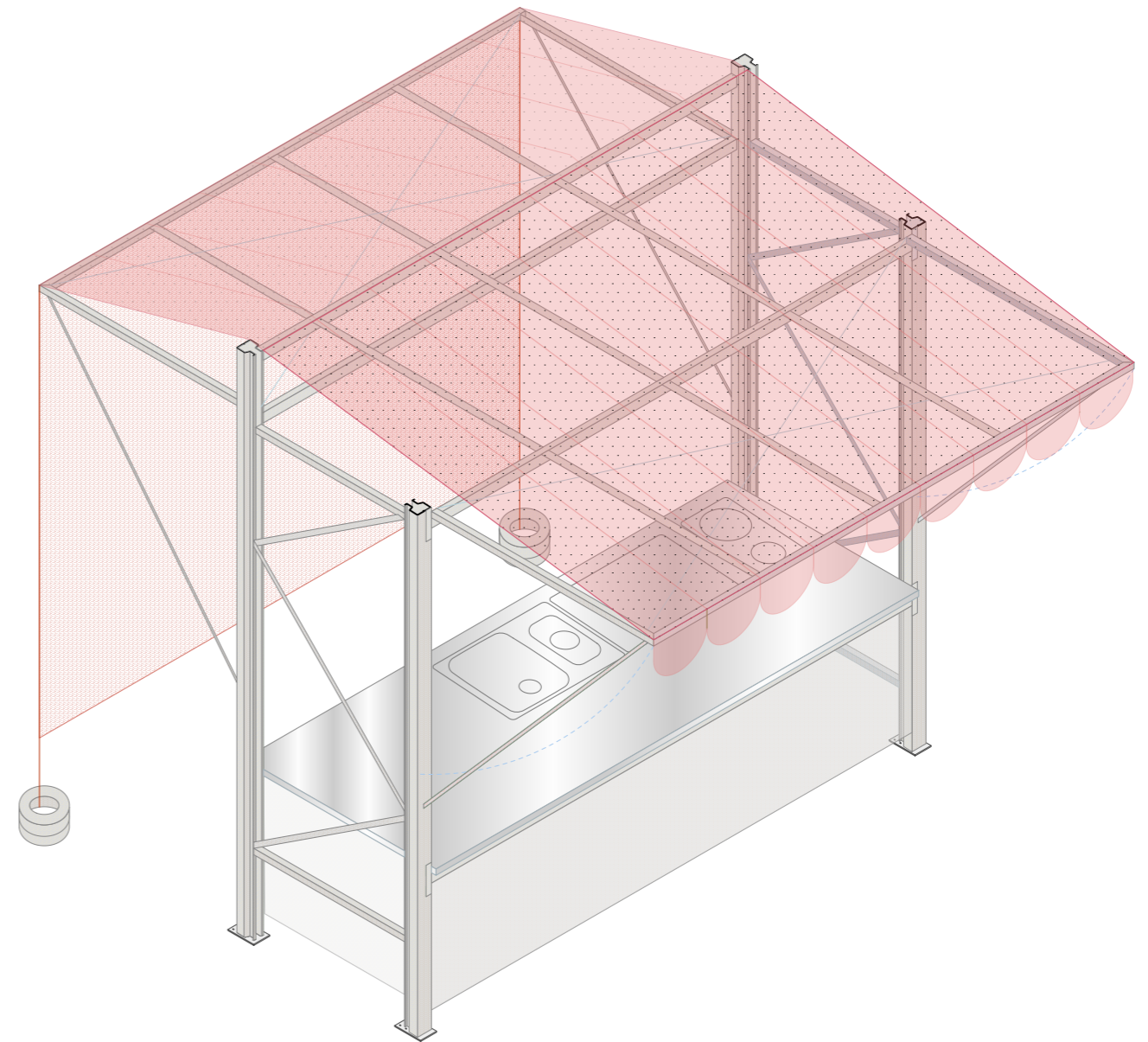

- Material: wood, metal, textile
- Function: kitchen
- screw joints





NEW ELEMENT 10

Data sheet:

-  Material: metal
-  Function: drone parking tower
-  screw joints

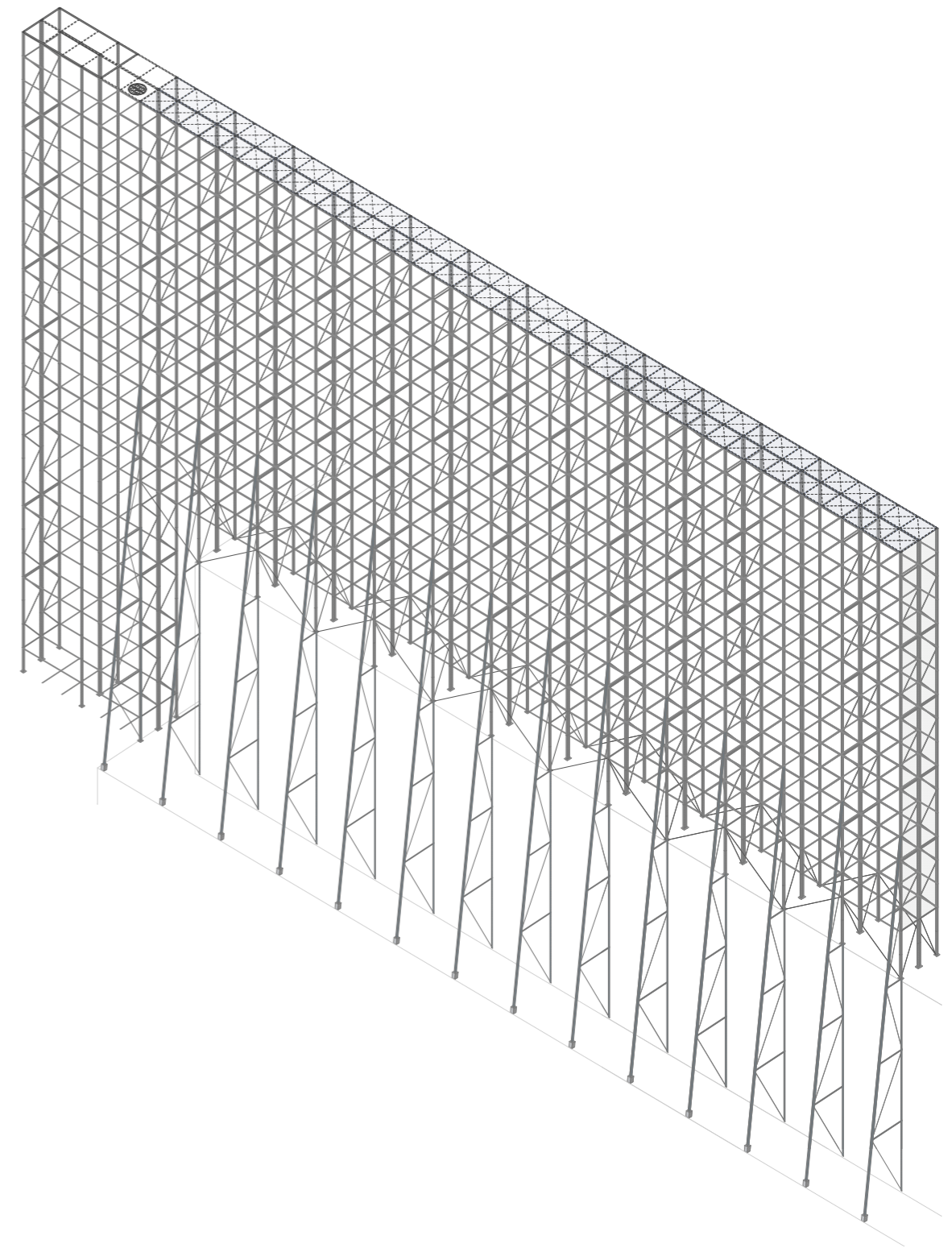

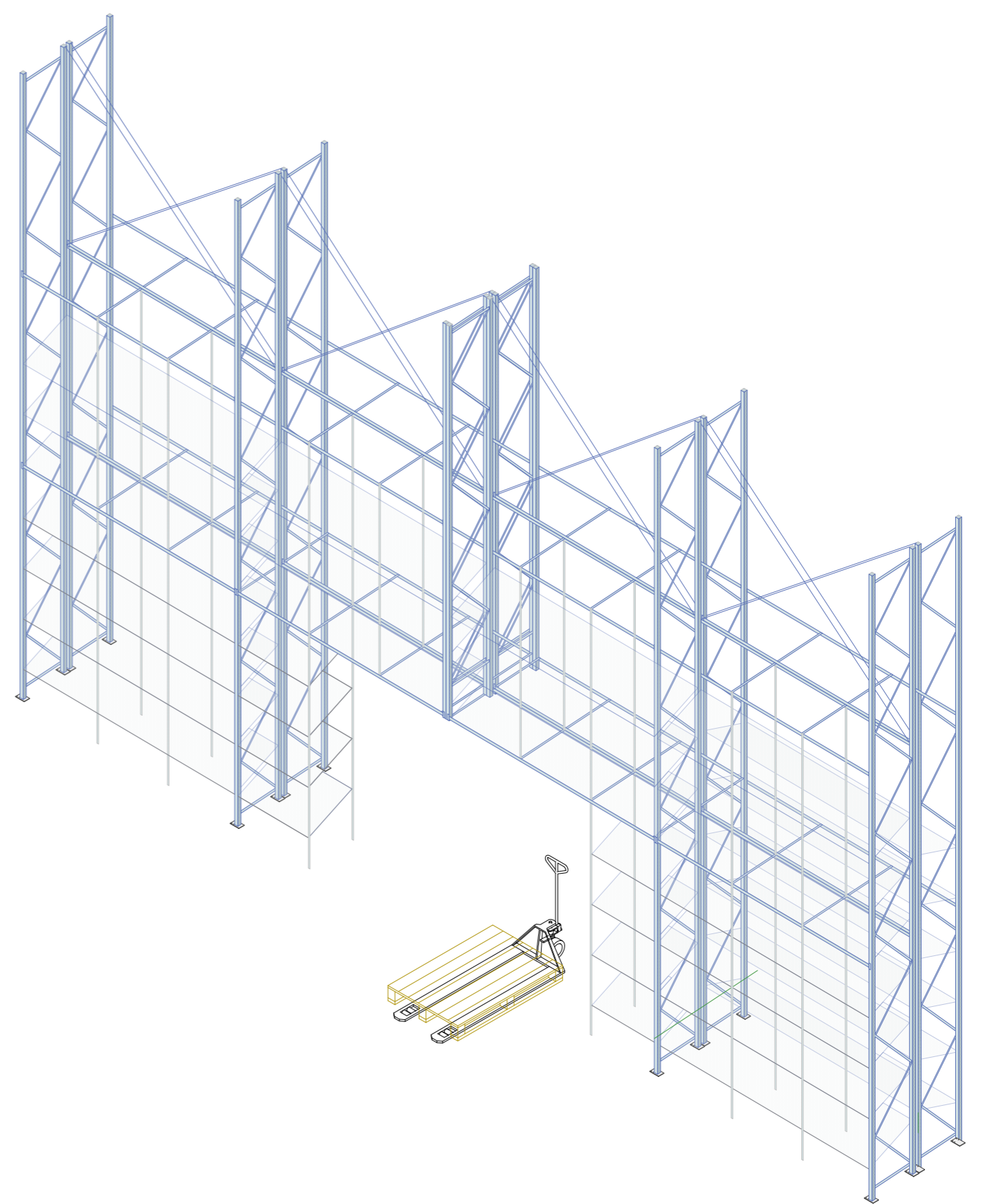

NEW ELEMENT 11

Data sheet:

- Material: metal
- Function: presentation wall, storage shelf
- screw joints

