

ETH D-ARCH
FS21

ATLAS OF ELEMENTS

DIPLOMA PROJECT
TALISSA WEDER

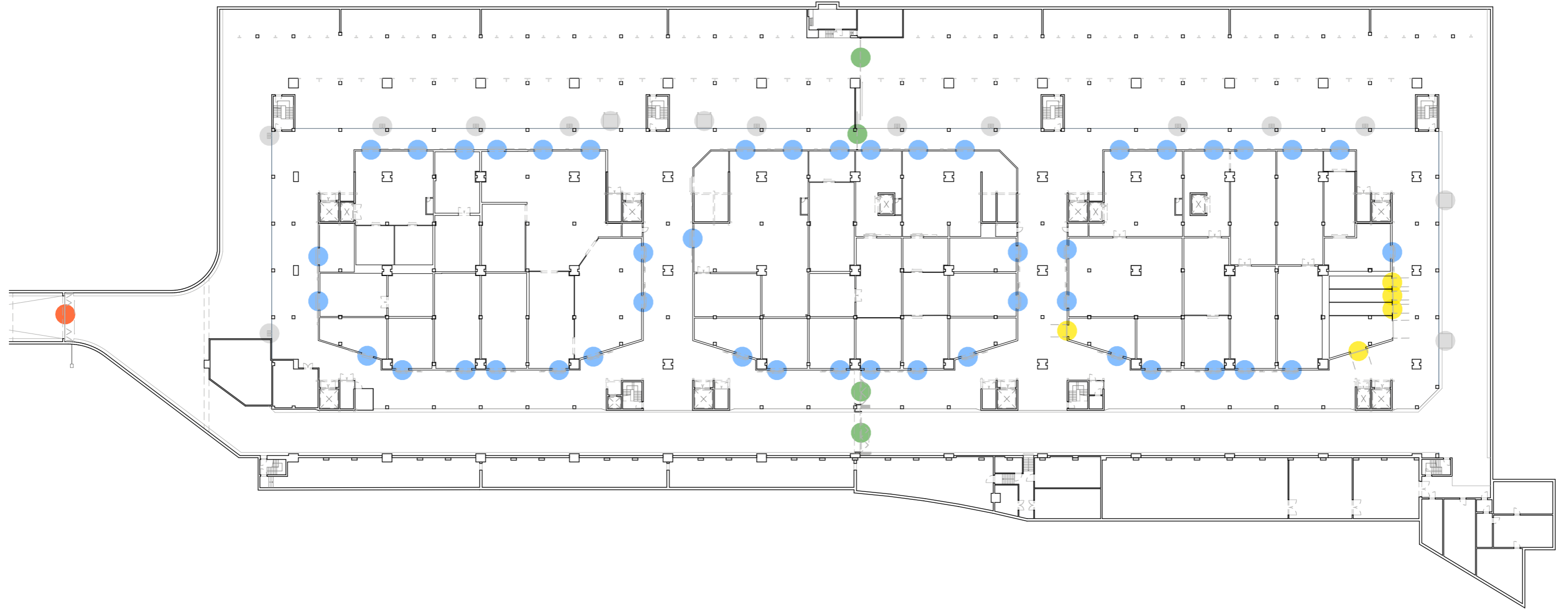

- D1
- D2
- D3
- D4

● V1

D1
Separates: outside and basement
Function: locking
Time: 10 sec
Material: iron, glass
Mechnaism: motorized, lockable
Open: through out the day

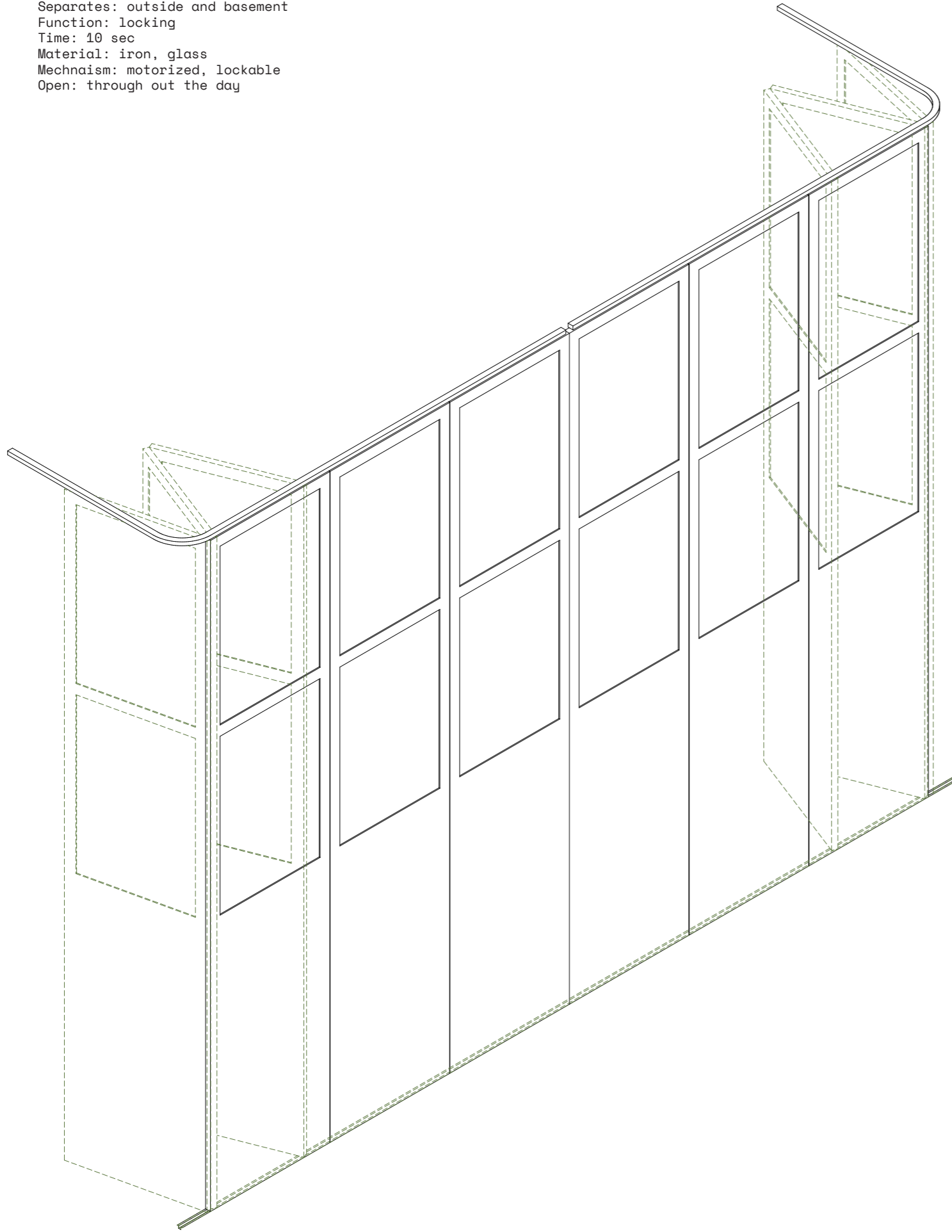

D2

Separates: corridor and cold room

Function: cooling and locking

Time: 5 sec

Material: plastic, insulation, painted steel

Mechanism: motorized, lockable

Open: throughout the whole day

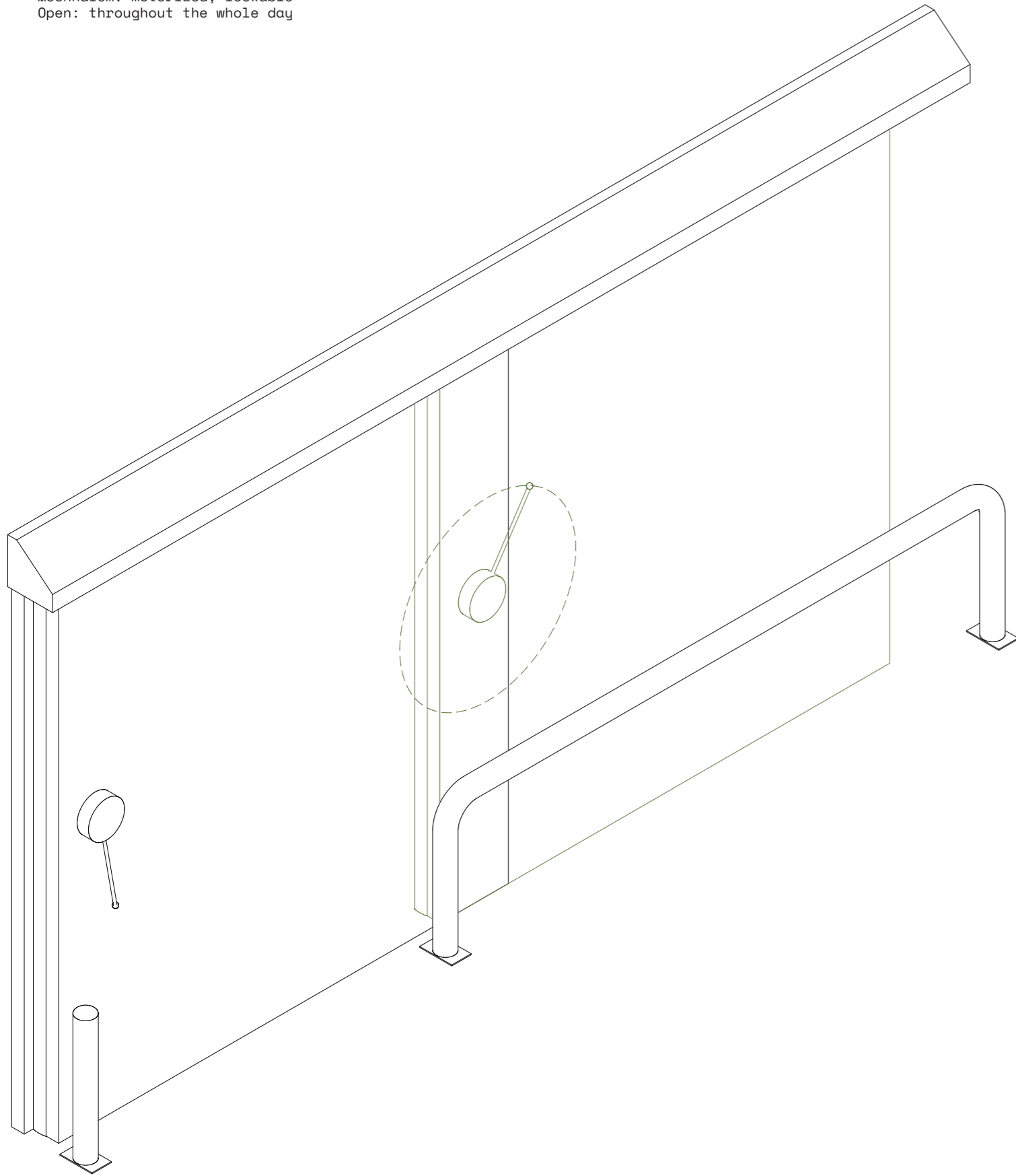

D3

Separates: corridor and banana ripening

Function: protection to ripen bananas

Time: 1 min

Material: plastic, steel, painted steel

Mechanism: motorized, lockable

Open: through out the day (banana ripening takes up to 7 days)

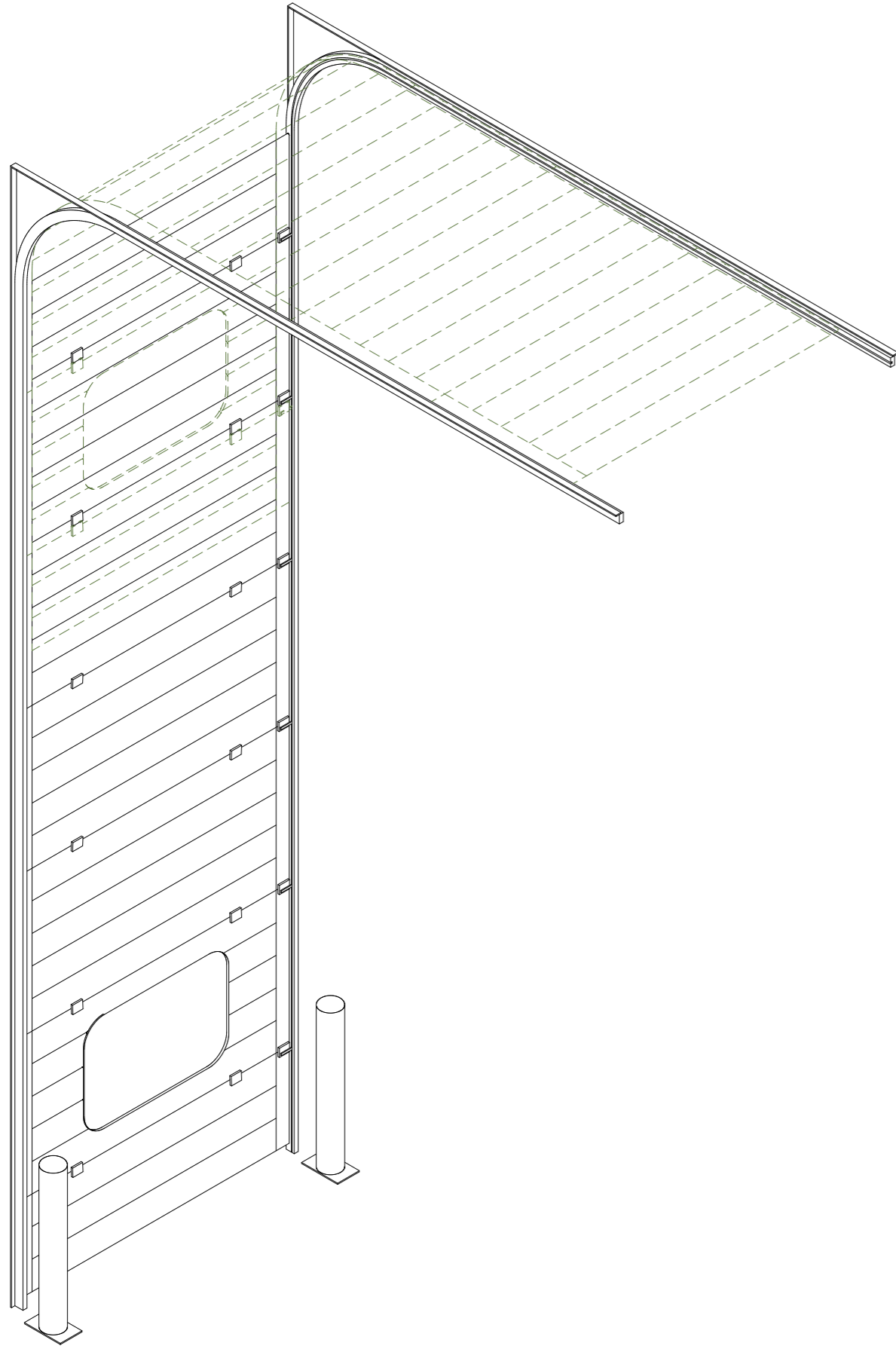





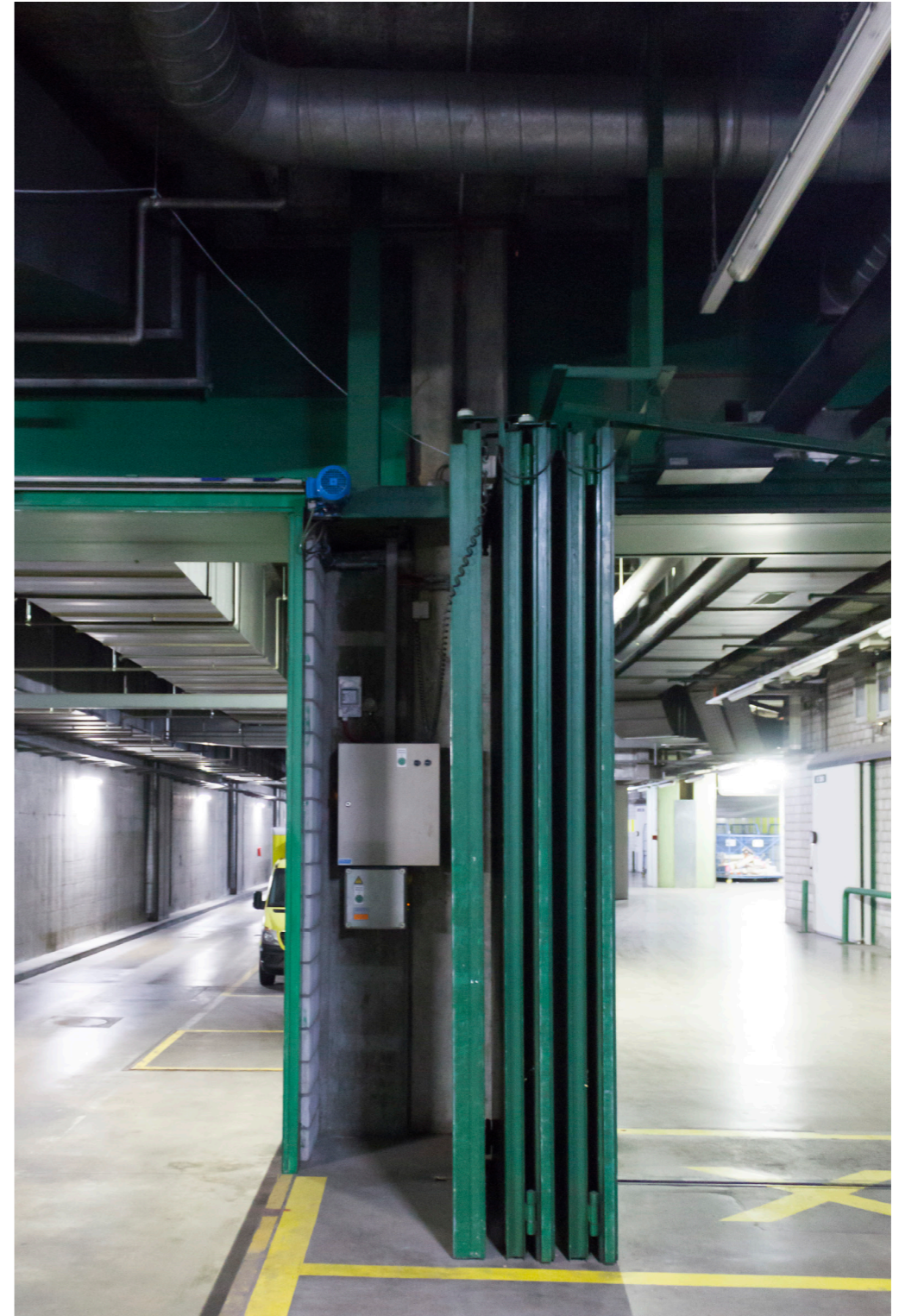
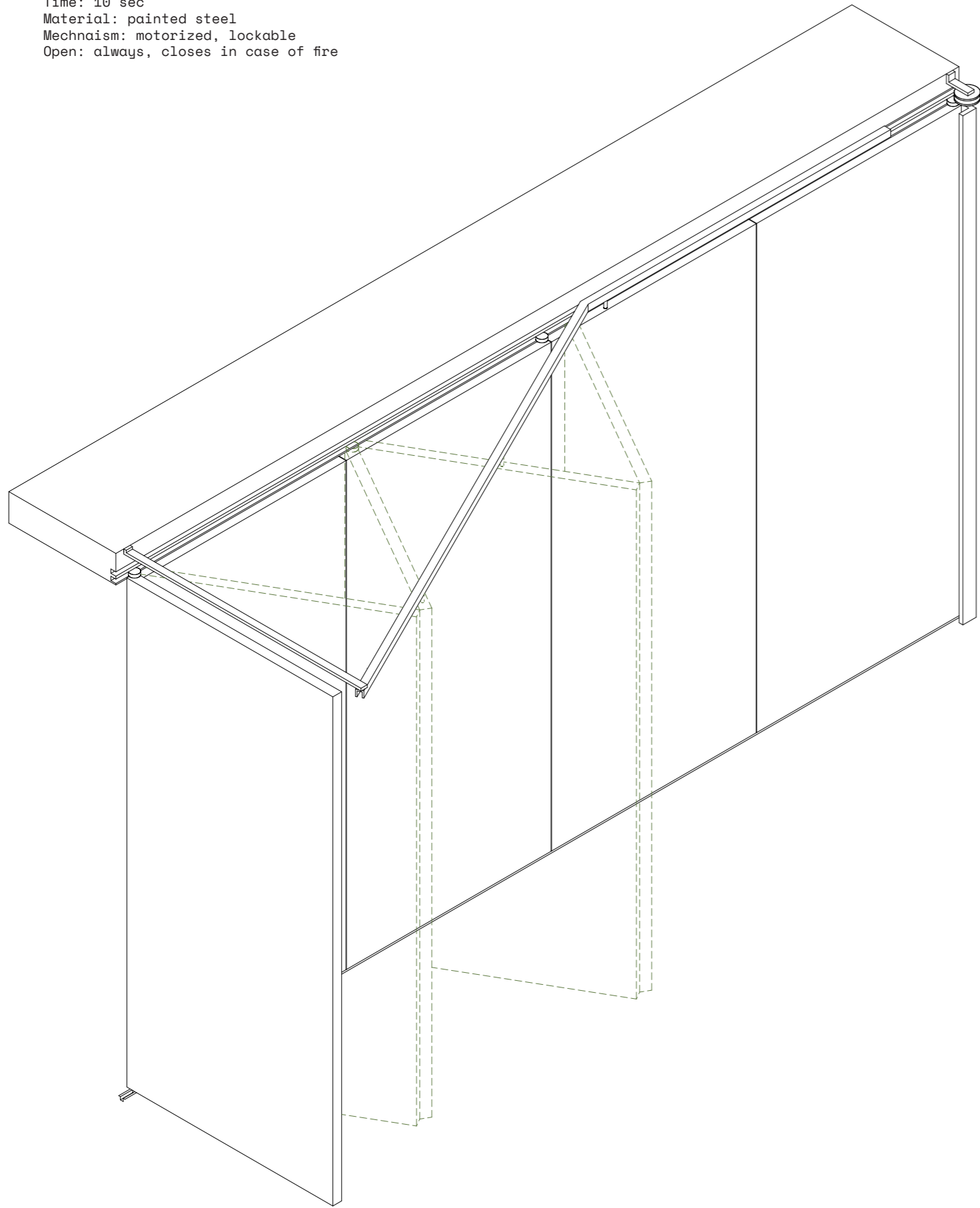

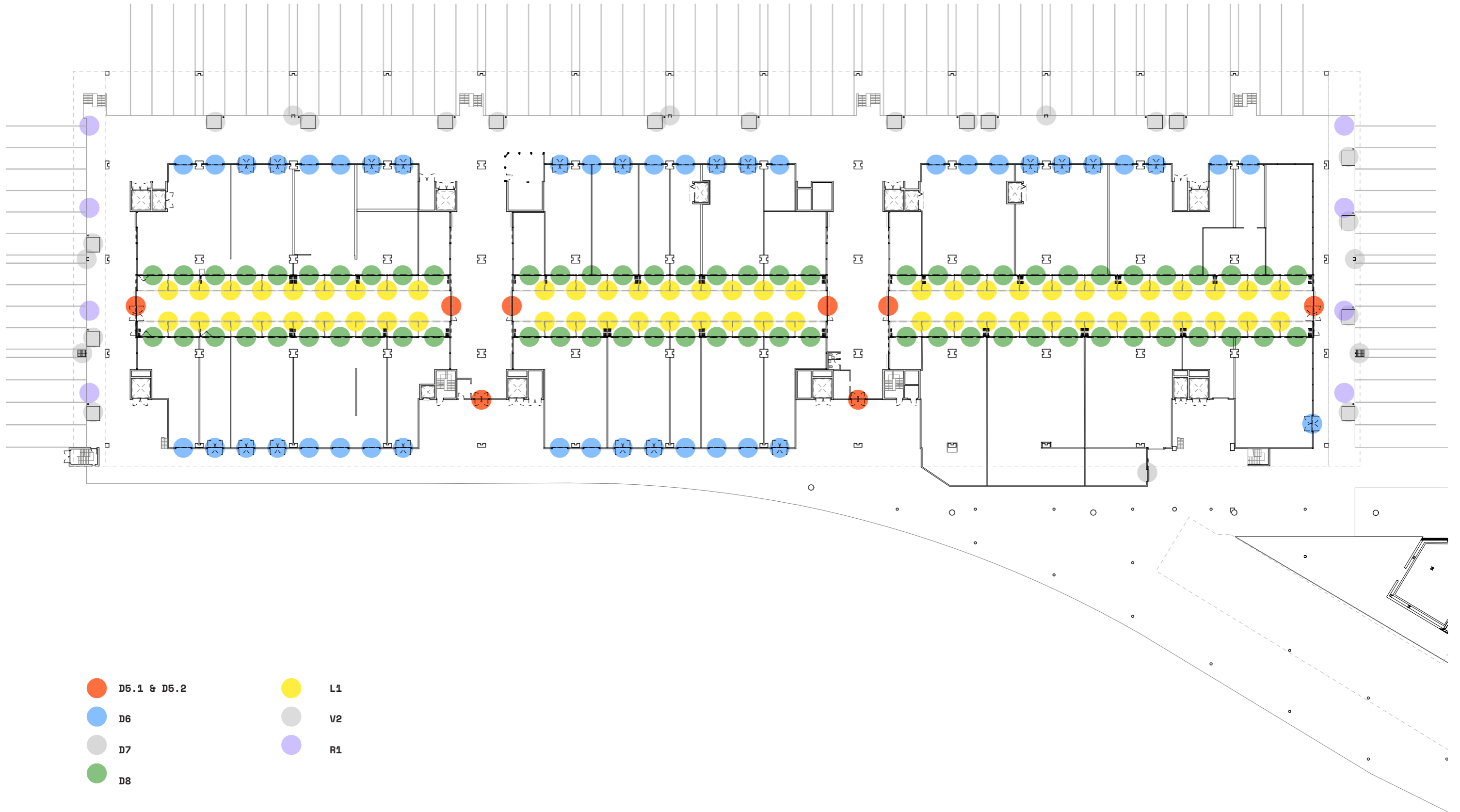

D4

Separates: corridor
Function: protection in case of fire
Time: 10 sec
Material: painted steel
Mechanism: motorized, lockable
Open: always, closes in case of fire



Groundfloor



- | | | | |
|---|-------------|---|----|
|  | D5.1 & D5.2 |  | L1 |
|  | D6 |  | V2 |
|  | D7 |  | R1 |
|  | D8 | | |

D5.1
Separates: outside and internal Street
Function: locking internal street
Time: 10 sec
Material: painted steel
Mechanism: human power, lockable
Open: the whole day (00:00 - 24:00)

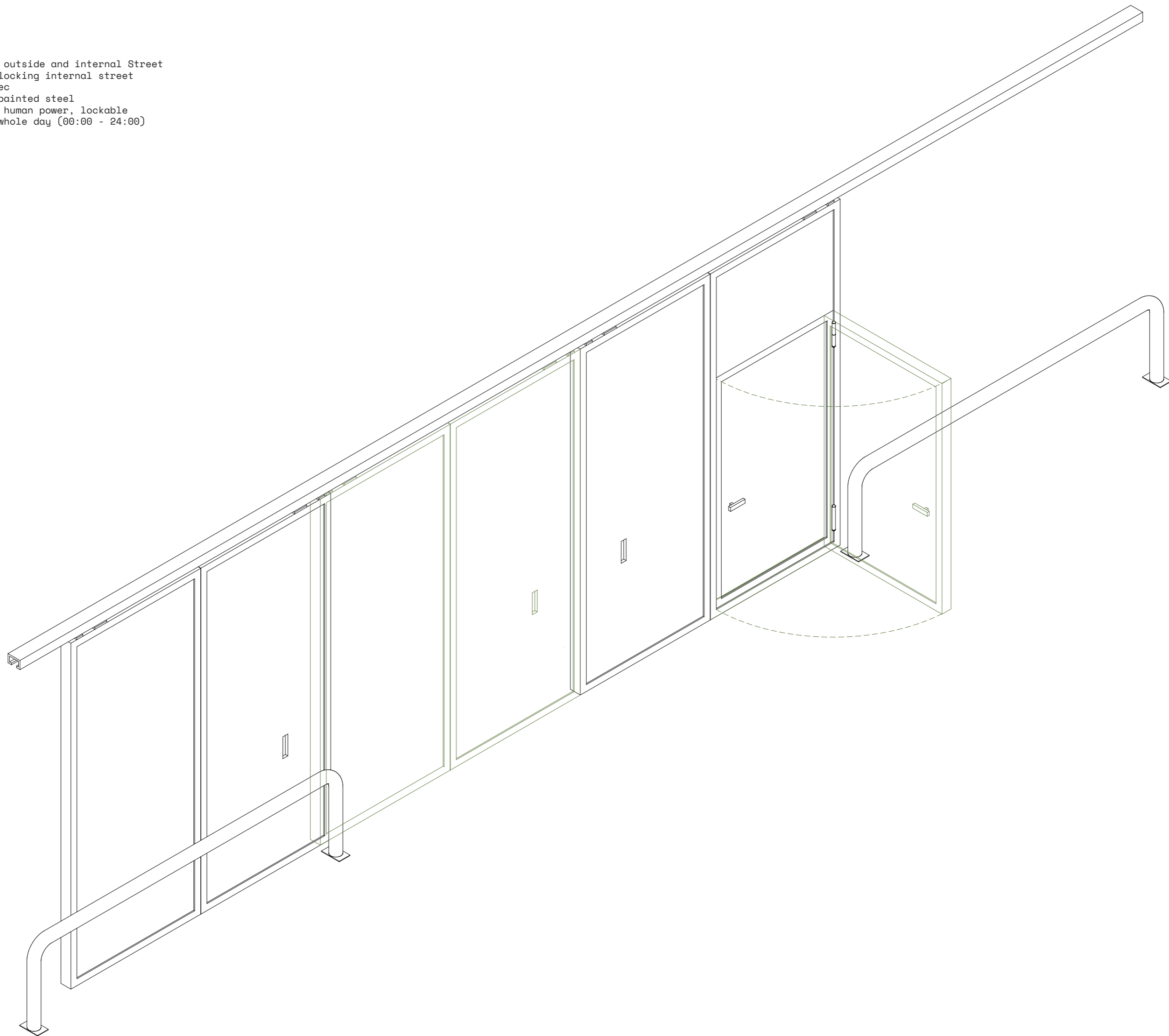

D5.2
Separates: outside and internal street
Function: transparent windbreak
Time: 2 sec
Material: plastic, galvanized steel
Mechanism: human power
Open: the whole day (00:00 - 24:00)

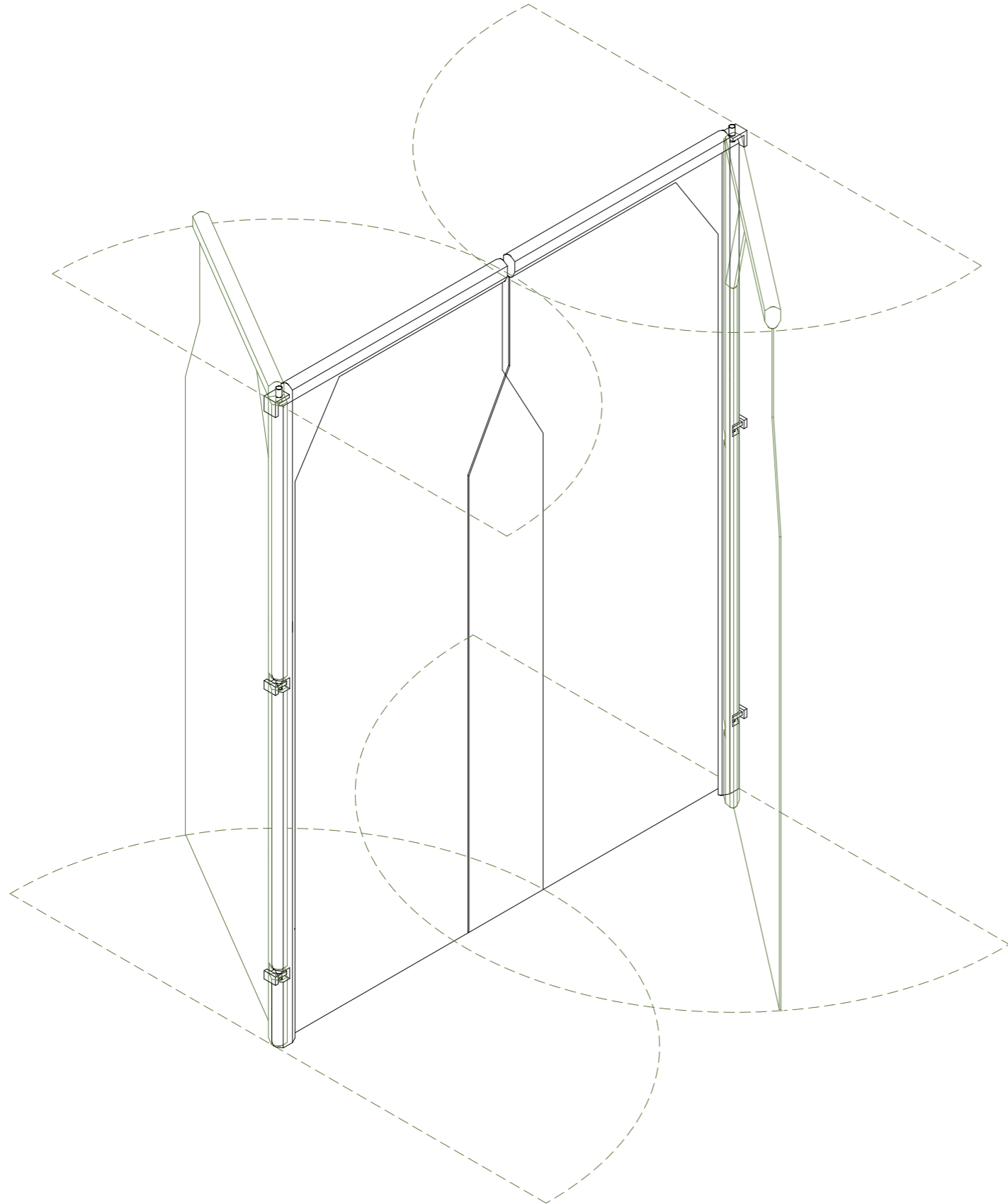

D6

Separates: outside and rented storage

Function: lock storage space

Time: 25 sec

Material: painted steel, proflit glass, plastic

Mechnaism: motorized, lockable

Open: 24:00 - 08:00; during the day when goods arrive

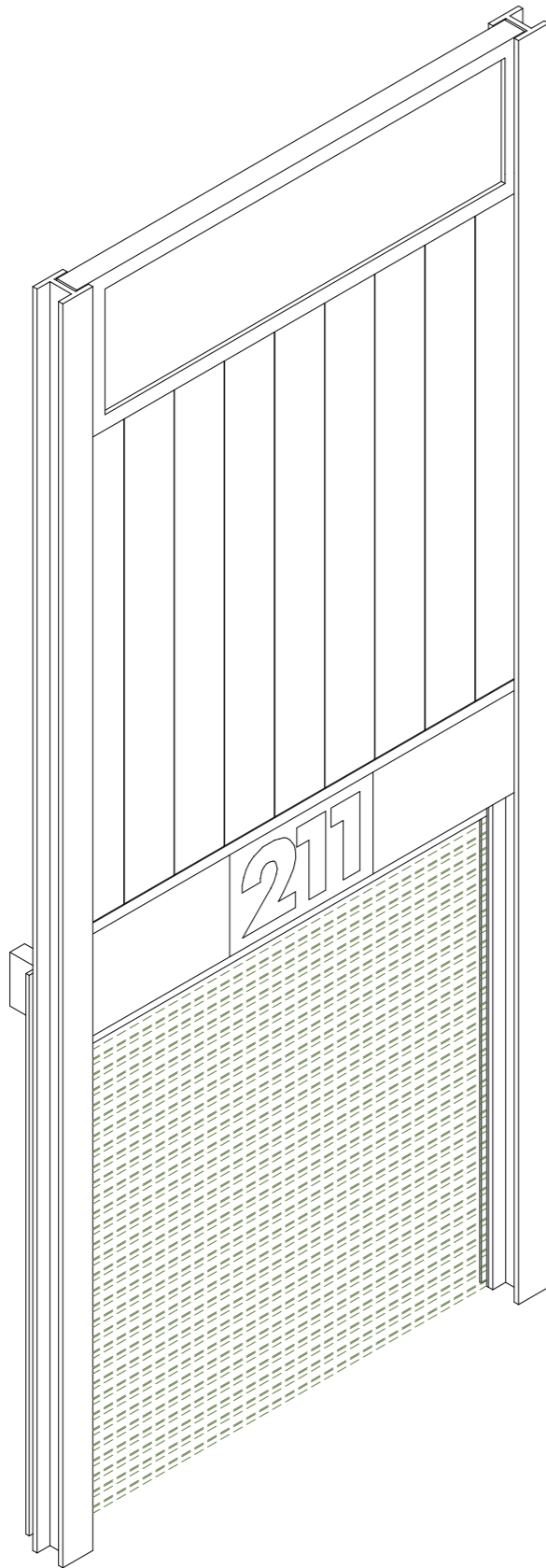

D7

Searates: outside and cold room

Function: transparent windbreak

Time: 1 sec

Material: plastic

Mechanism: human power, not lockable

Open: 24:00 - 08:00; during the day when goods arrive

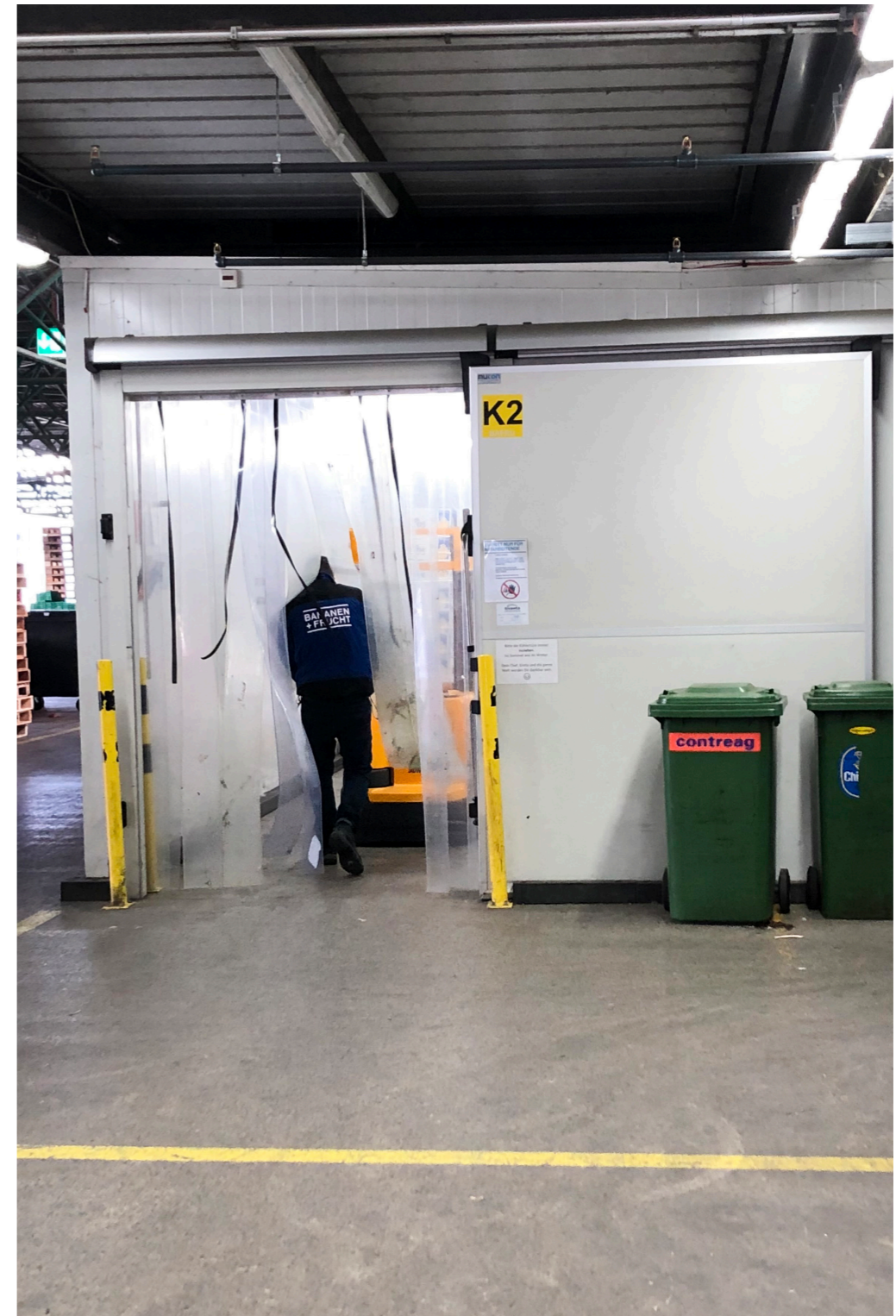
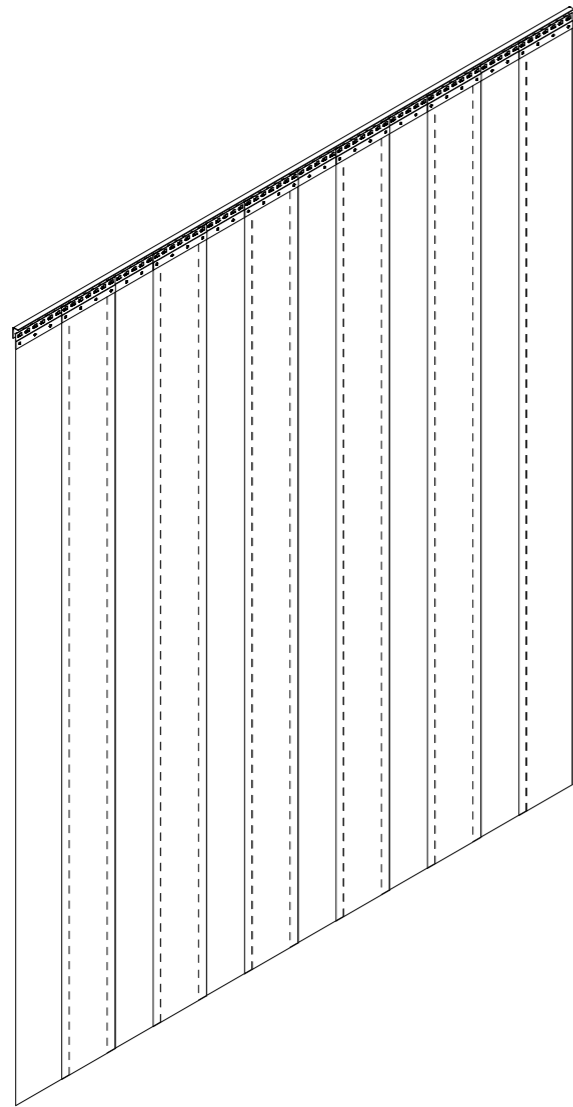

D8

Separates: internal street and rented storage

Function: lock storage space

Time: 20 sec

Material: painted steel

Mechanism: human power, lockable

Open: 24:00 - 08:00; during the day when goods arrive

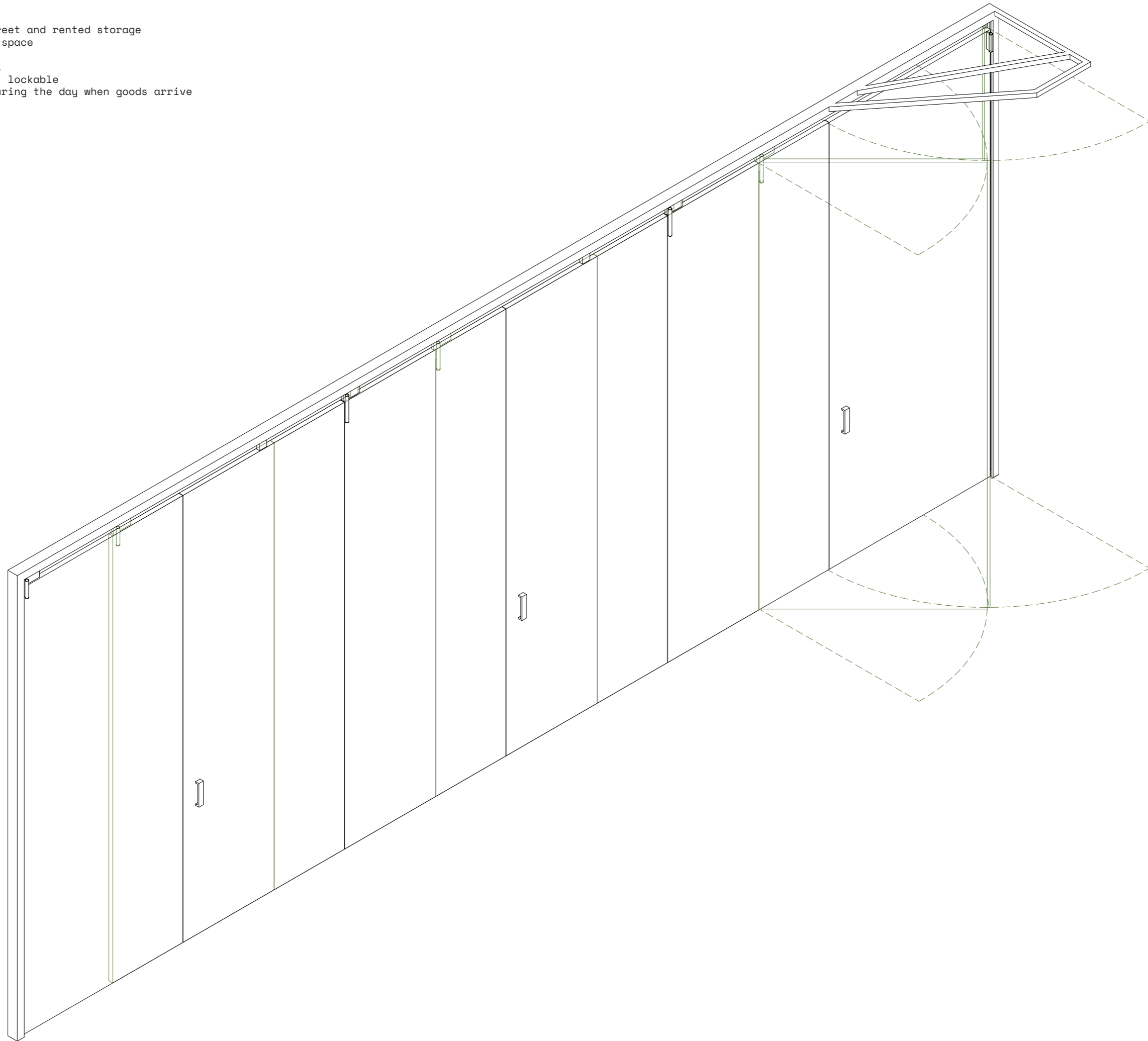



DUBNO
FÜR KENNER & GENIESSER

www.thurgauerbeeren.ch

Thurgauer
Beeren
www.thurgauerbeeren.ch

Thurgauer
Beeren
www.thurgauerbeeren.ch

egger
gemüsebau
werbühnl

egger
gemüsebau
werbühnl
rey

GENTILE AG

Haegeli
AGRO

GENTILE AG

R1
Function: shelter, sun protection
Material: painted steel, concrete

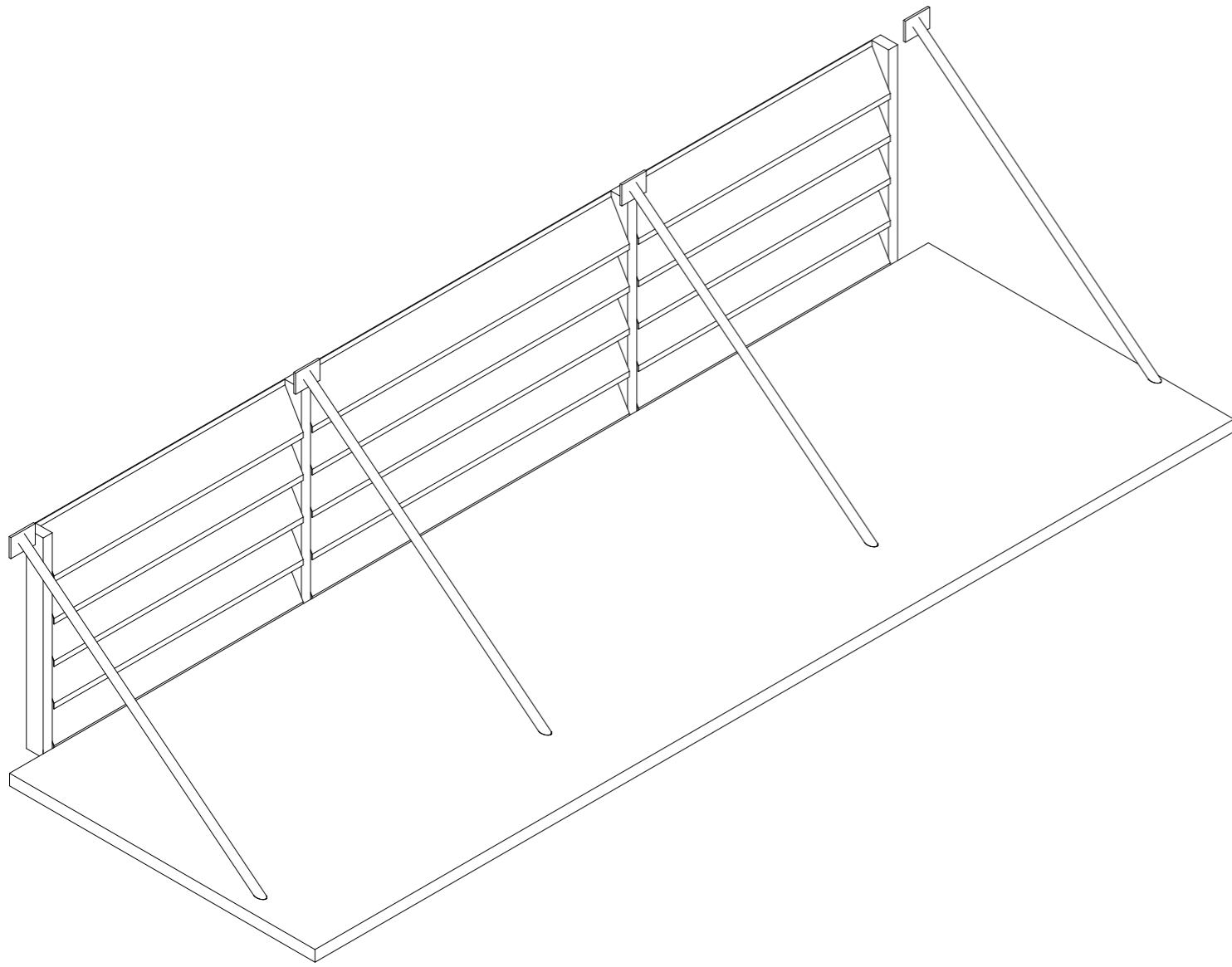

V2

Connects: marshalling area and building

Function: access

Time: 3 sec

Material: steel, concrete

Mechanism: motorized, human power

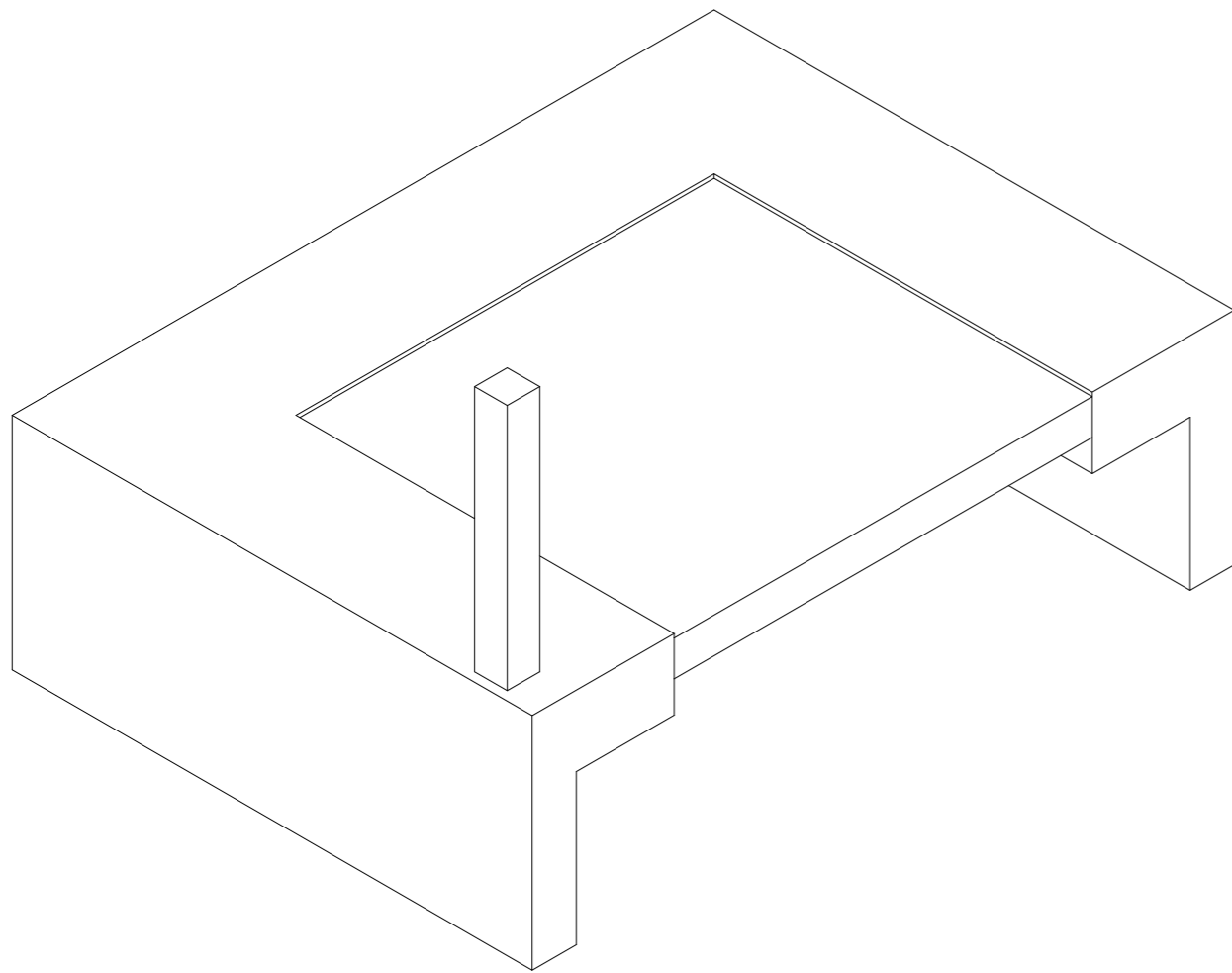
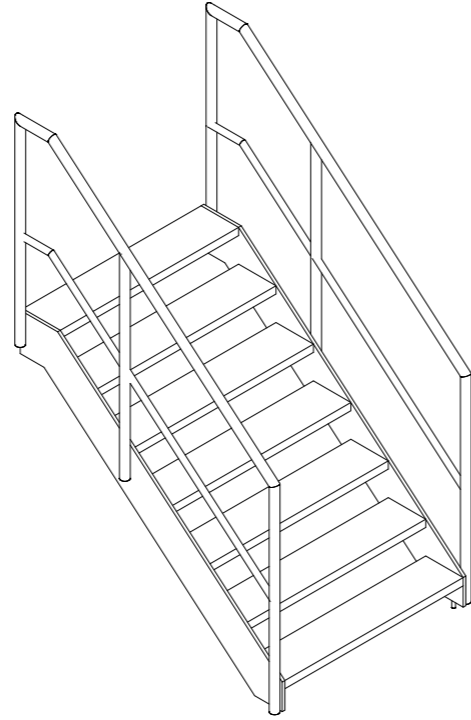
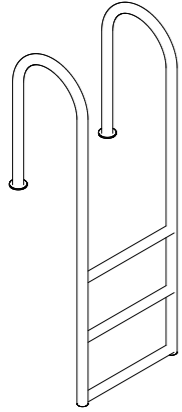

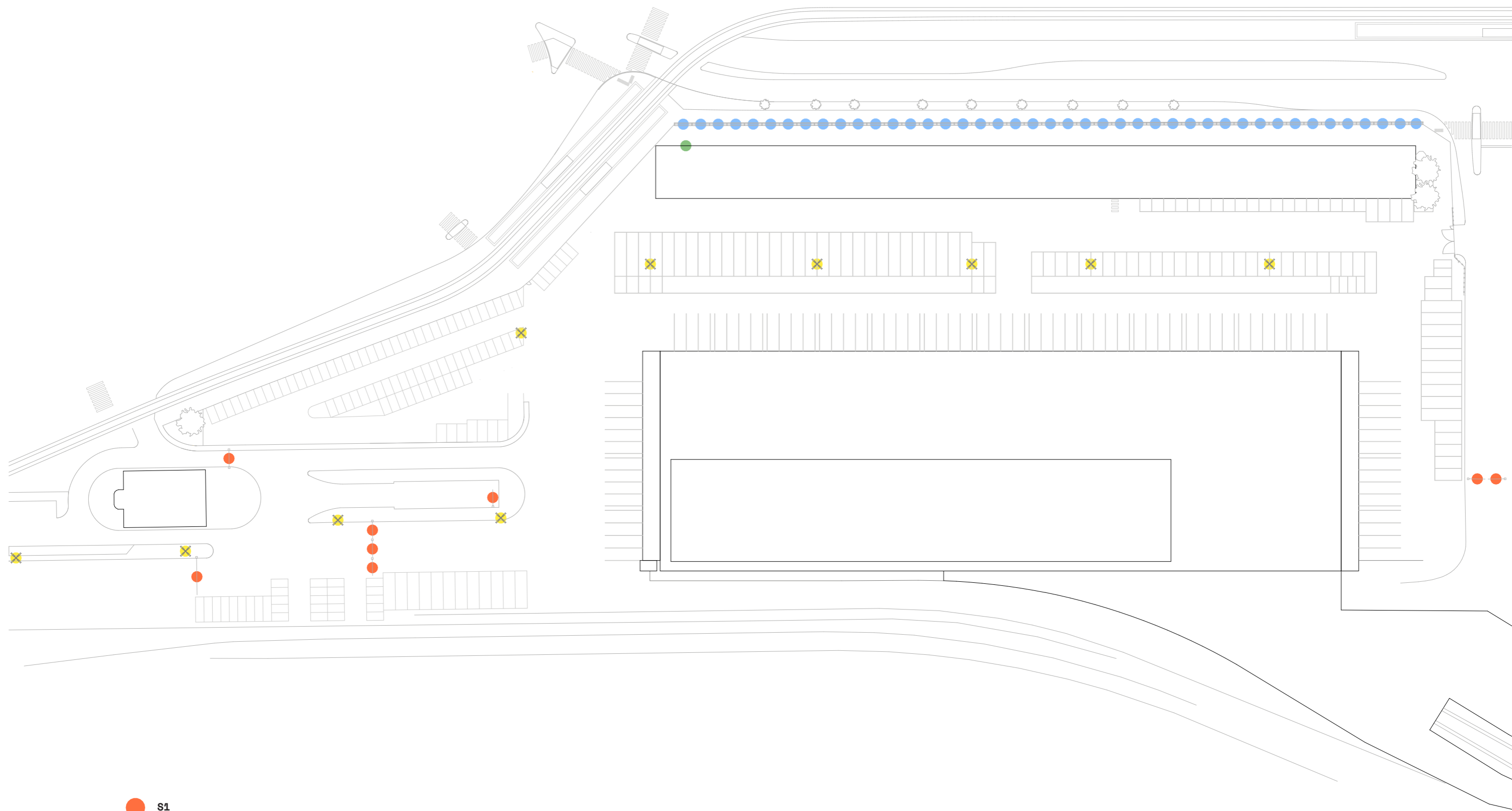

- S1
- F1
- L2
- L3

S1
Separates: site and pfingstweidstrasse
Function: regulate access
Time: 3 sec
Material: plastic, steel

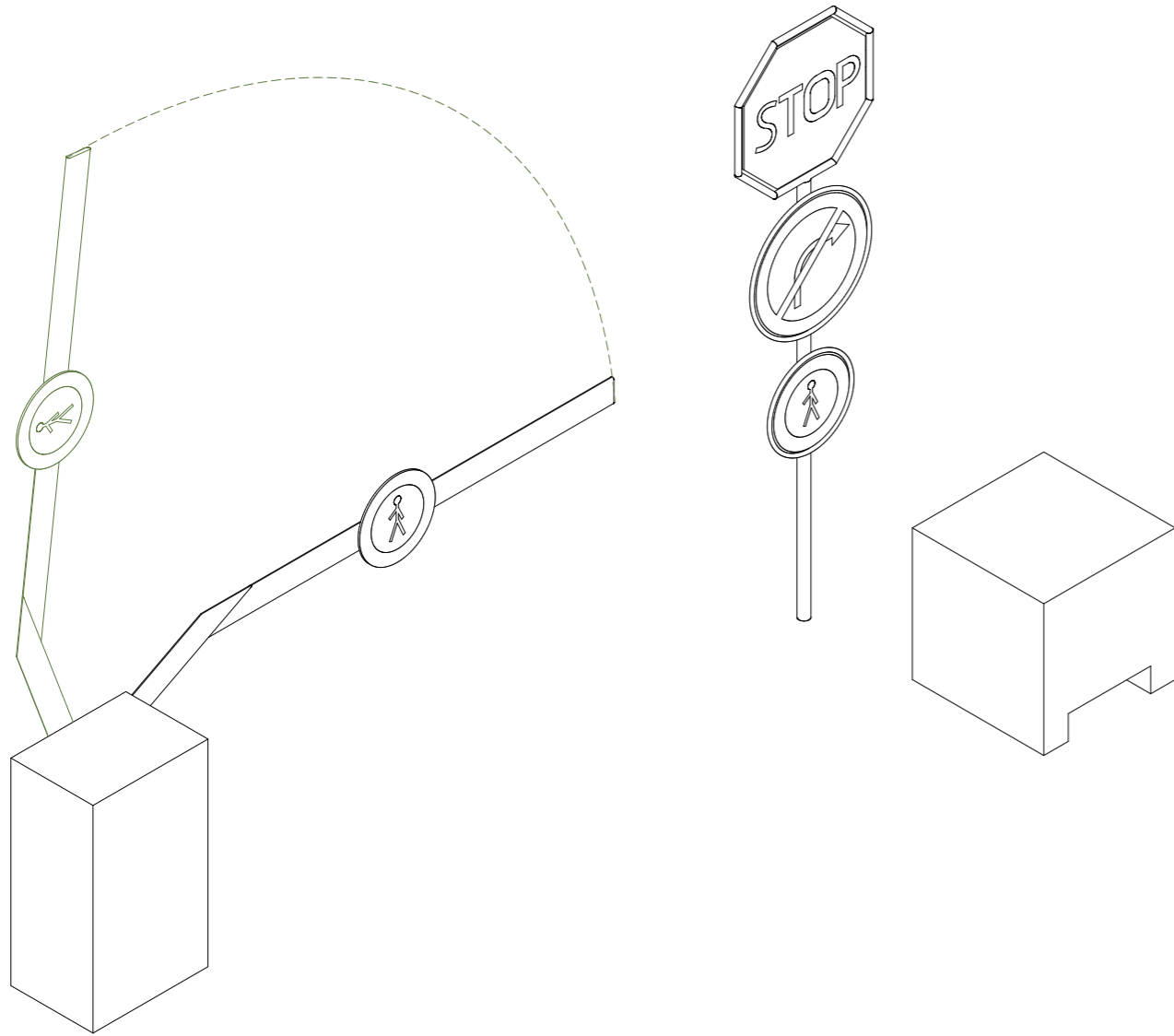

L2

Function: enlight the site

Material: steel, concrete, plastic

On: at night

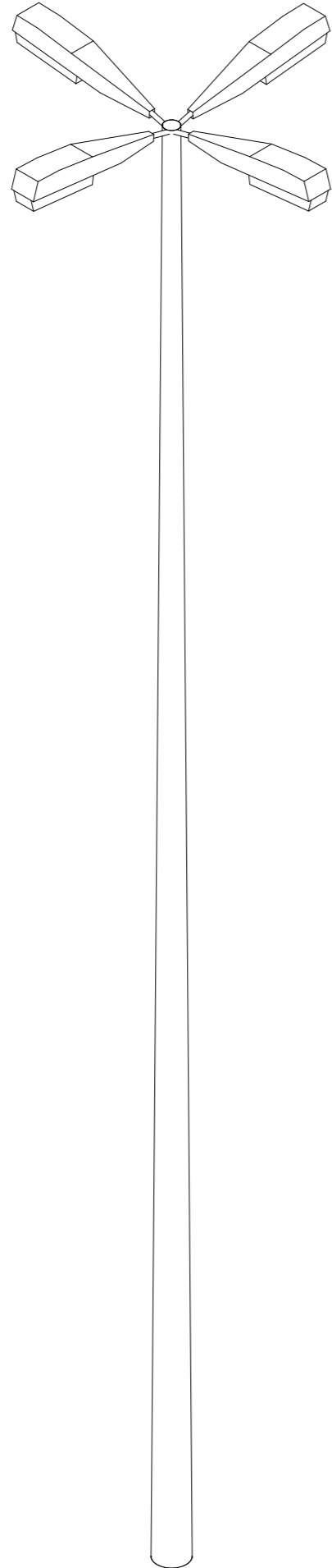

S2
Function: light as sign
Time: 1 sec
Material: metal, neonlight

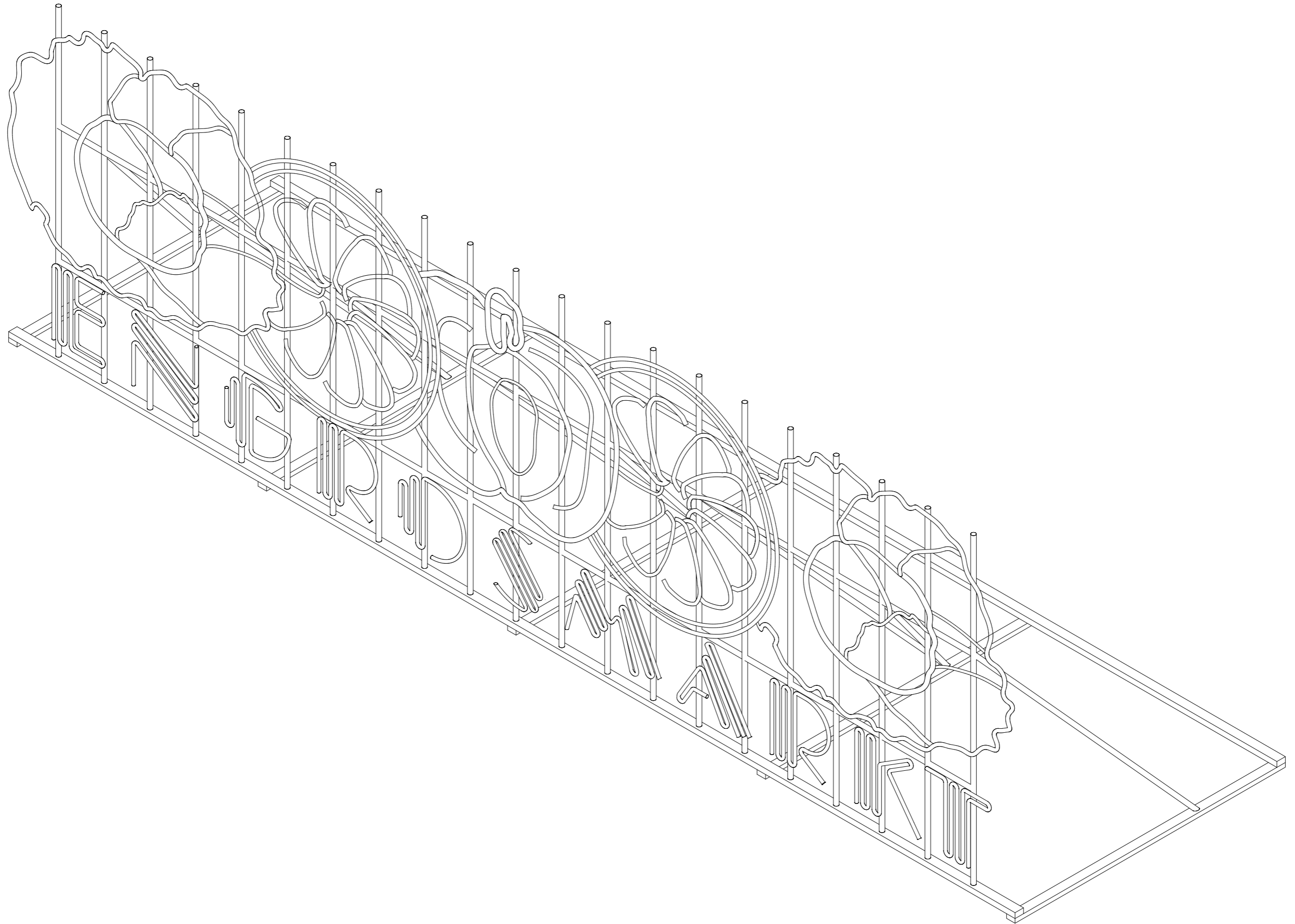

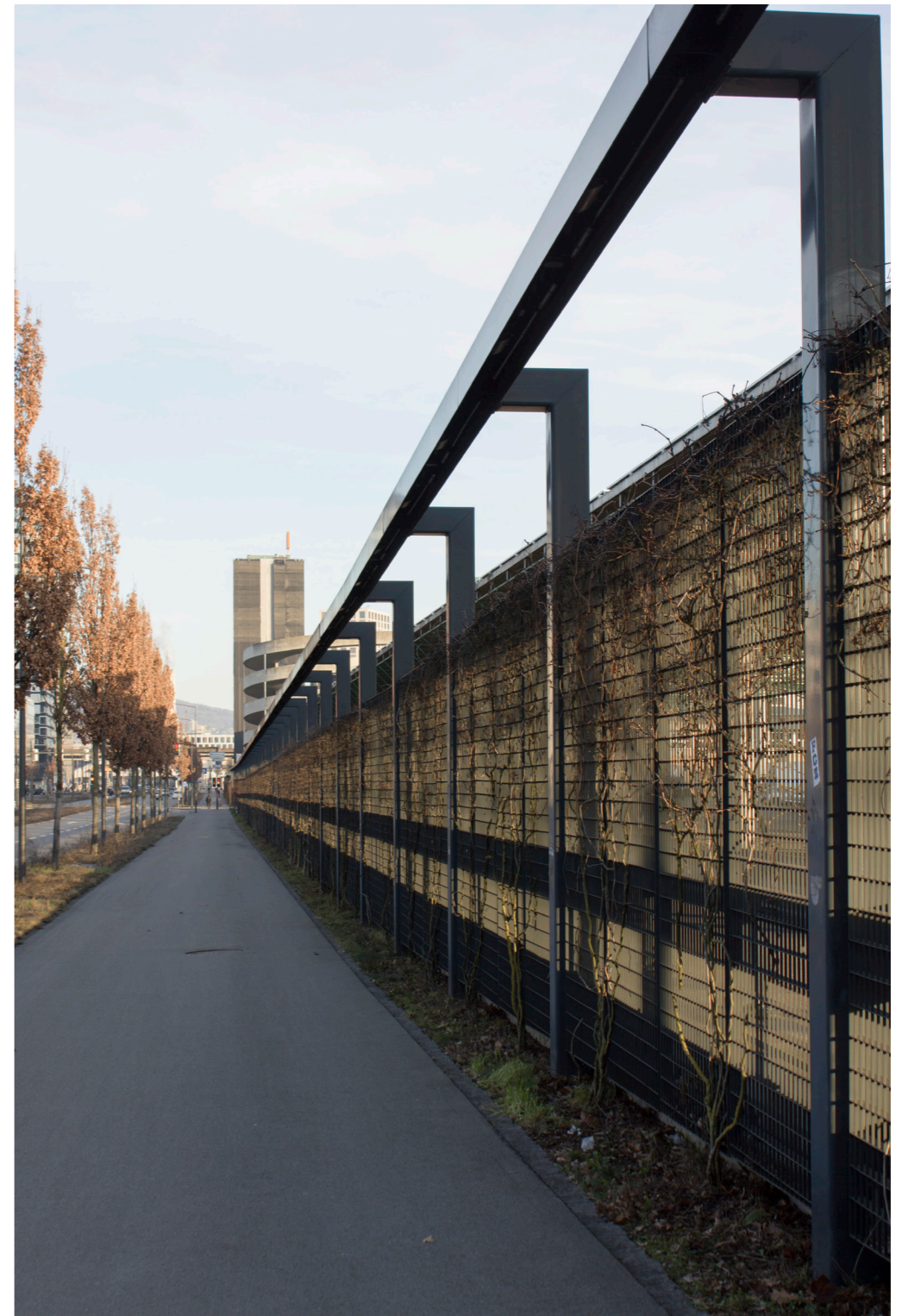

F1
Separates: engrosmarket and street
Function: treshhold
Material: steel

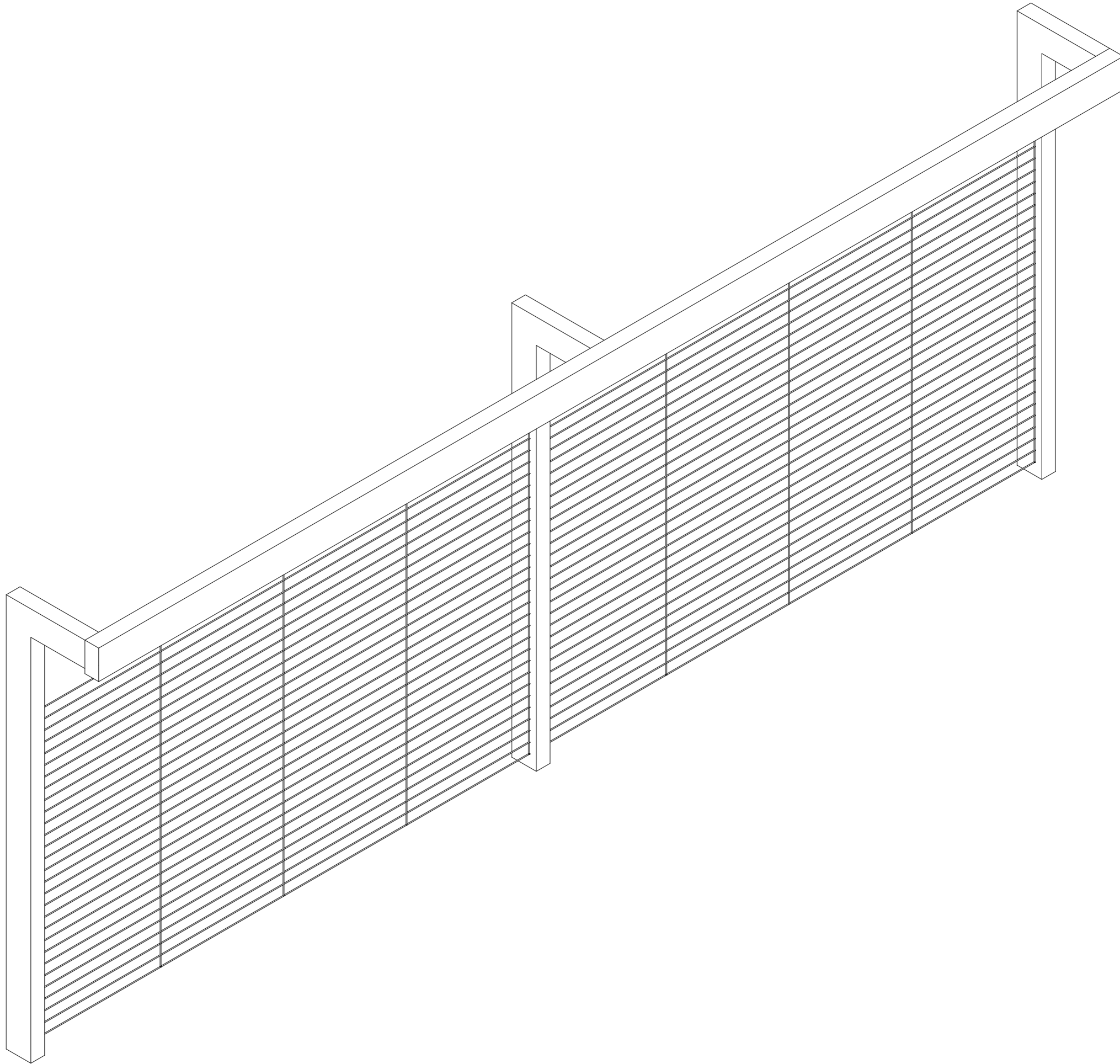

**ATLAS
OF
ELEMENTS**

Talissa Weder
Diploma Project FS21

Topic C
24/7 Metropolitan Hybrid Machine

Prof. Adam Caruso

Assistants
Emilie Appercé, Claudio Schneider